

Item # 60246 (LH) & 60247 (RH)

DOUBLE THRESHOLD ACRYLIC SHOWER BASE MINIMALIST PROFILE

72" x 36" x 2 1/2"

2 1/2" = threshold height not including tiling flange.

Note: Shower base may not be exactly as pictured.



PRODUCT SPECIFICATIONS

- High gloss acrylic backed with fibreglass and reinforced with wood.
- Leveling feet included.
- Designed for corner installations.
- Shower base is trimmed to fit a 72-inch x 36-inch rough opening.
- 1-inch high integral tiling flange.
- Available in white.
- Standard 3 3/8" shower drain opening.
- Shower drains sold separately:
 - Item # 03001 - White
 - Item # 03004 - Chrome
 - Item # 03003 - Brushed Nickel
- 1 year limited manufacturer's warranty included.

DIMENSIONS

- Diagrams not to scale.
- All measurements ±1/4".

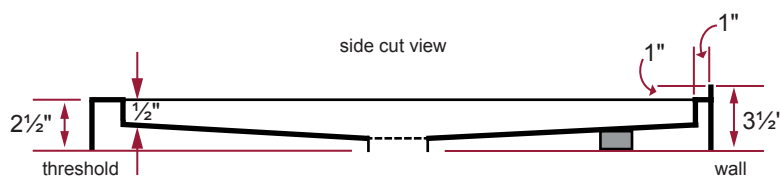
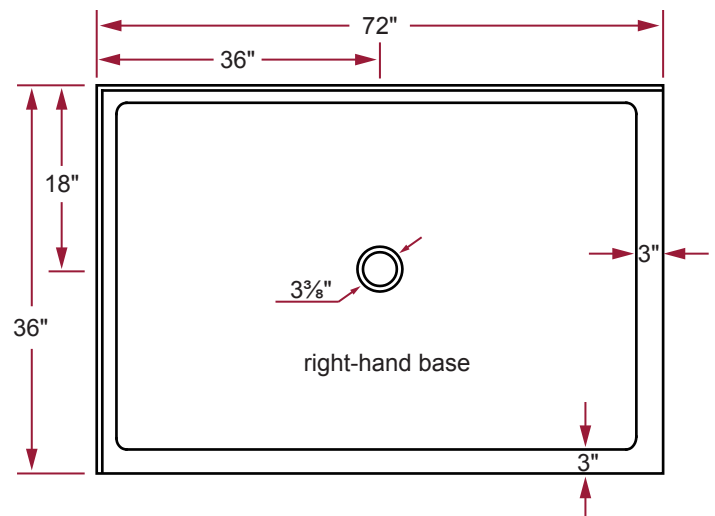
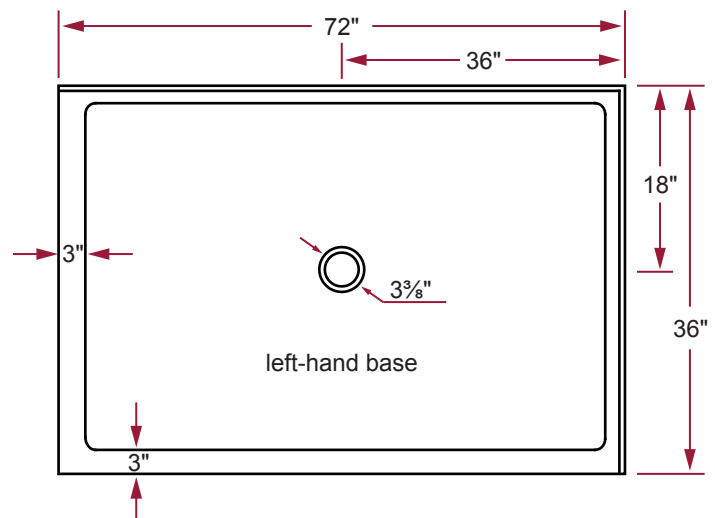

This product complies with CSA Standards

In keeping with our policy of continuing product improvement, Acri-Tec Industries Corp. reserves the right to change product specifications without notice.