

# avenue



Massa ITL-5001-EW  
Intelligent Toilet





- Prior to installation and use, please read this operating manual carefully.
- To ensure that timely and effective service is available for you, please keep this manual for future reference.
- Full instructions and videos are located on our website, please visit: [avenuecanada.ca](http://avenuecanada.ca)



5970 Chedworth Way,  
Unit B, Mississauga,  
Ontario, Canada  
L5R 4G5

1-888-256-7551  
[www.avenuecanada.ca](http://www.avenuecanada.ca)

 /avenue.fgi  
 /user/FGI Canada

 @avenue.fgi

# avenue



Massa ITL-5001-EW  
Intelligent Toilet

## NAME OF PARTS

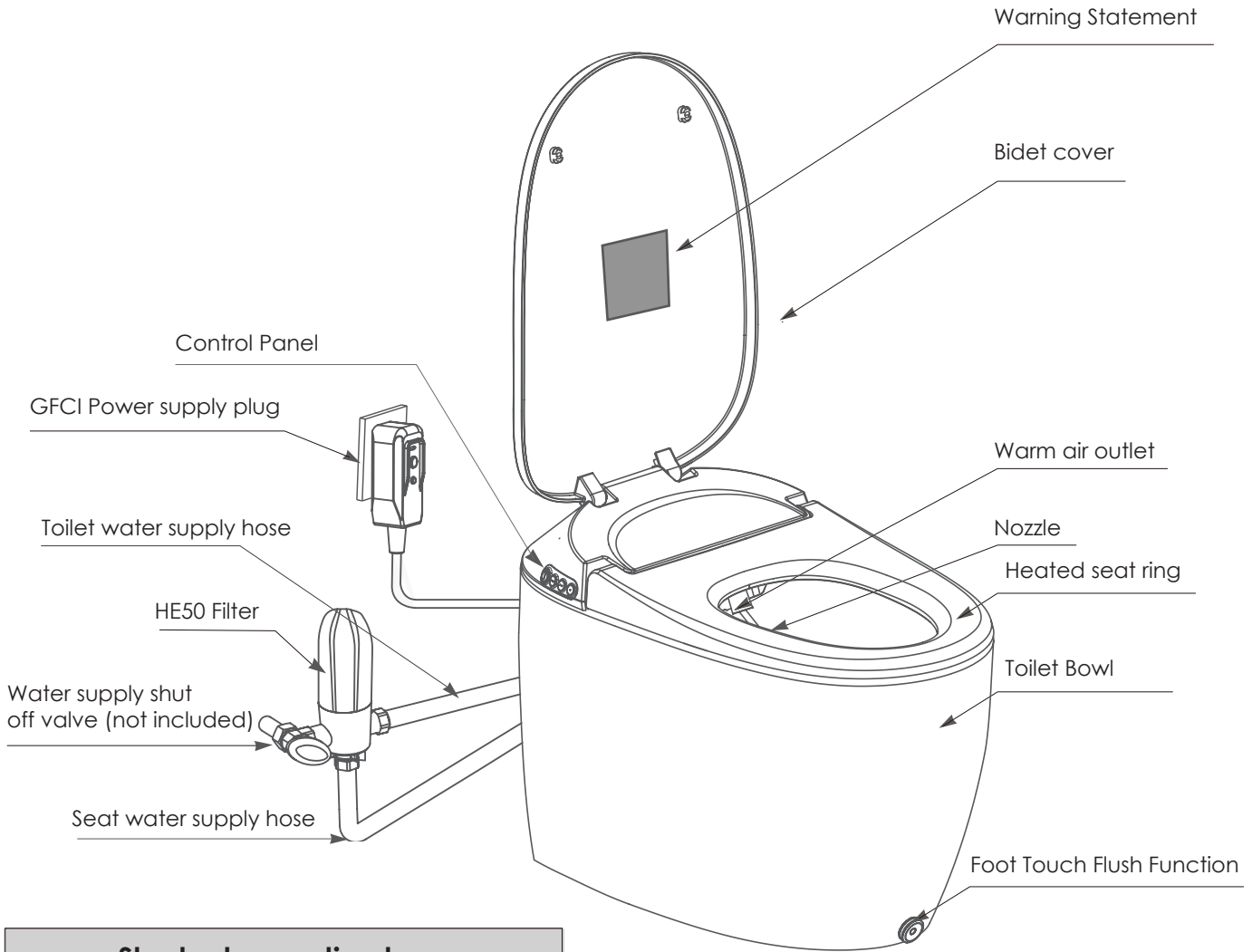

### Shortcut operation keys

Power/Stop    Posterior    Bidet    Flush

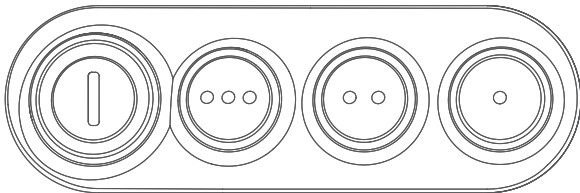

# avenue



Massa ITL-5001-EW  
Intelligent Toilet

## KEYS OF REMOTE CONTROLLER

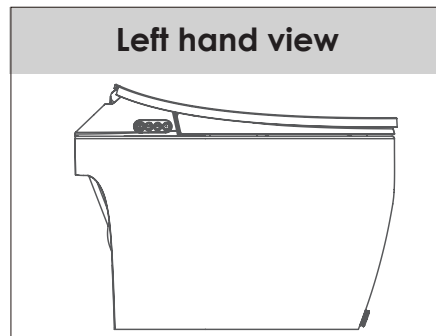
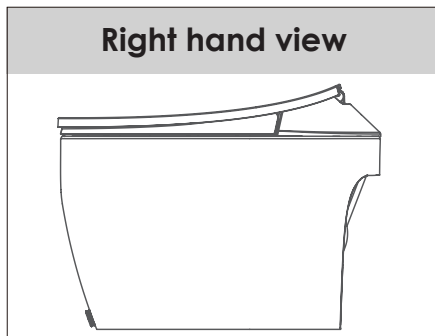
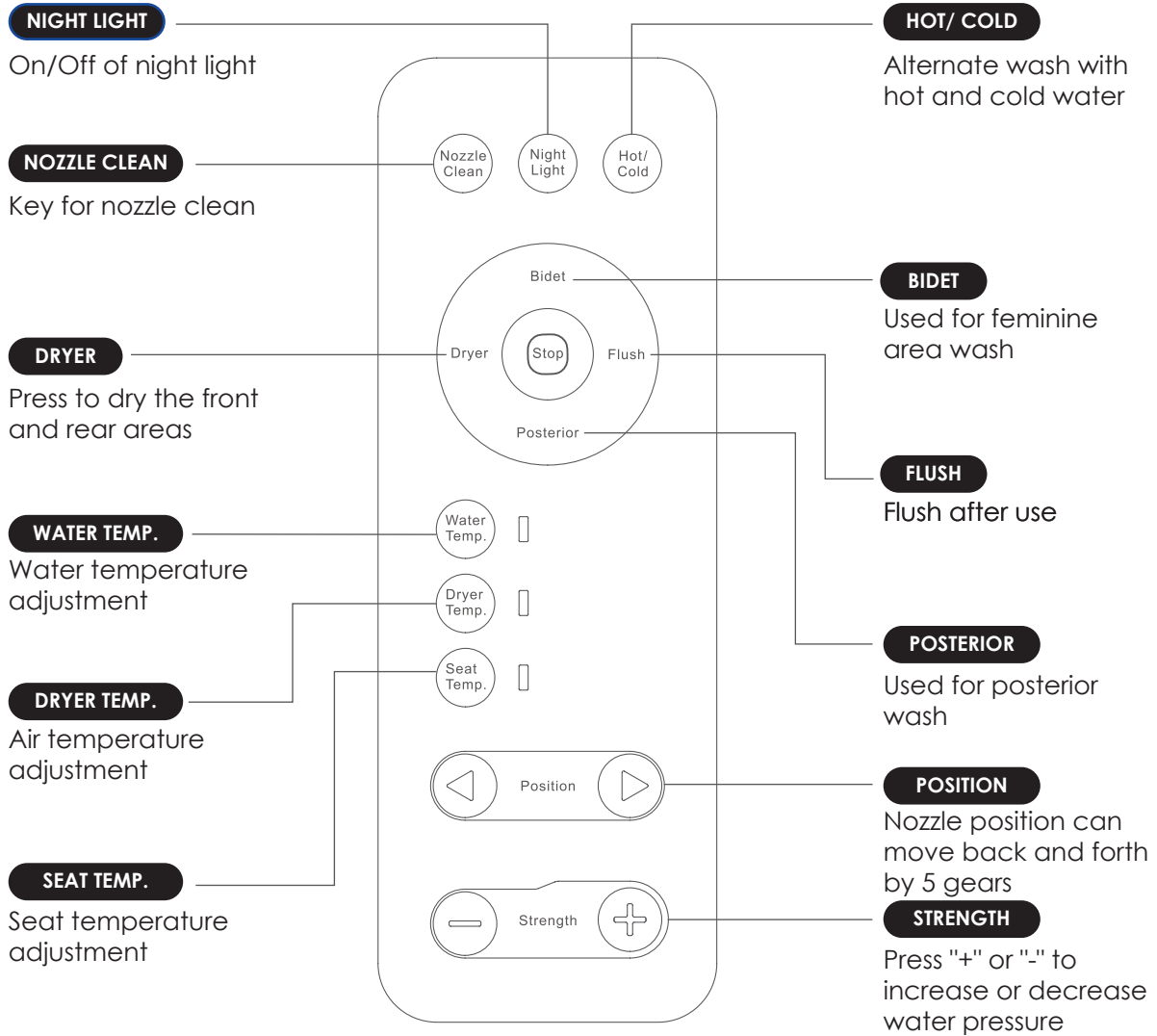

# avenue



Massa ITL-5001-EW  
Intelligent Toilet

## ATTENTION - PLEASE READ CAREFULLY

Thank you for purchasing this product from our company. To ensure proper use of this product, please read this manual carefully prior to use. Please retain this manual for future reference.

These notes contain important safety-related contents. Significant consequences may result according to different situations. Please follow these carefully to ensure a safe operating toilet.

## EXPLANATION OF TERMS AND MARKS

**Warning** . . . . Indicates that harm may result in case of negligence, and the user should adhere to warning symbols of this sign.

**Attention** . . . . Indicates that human injury or property loss may be result in case of erroneous operation due to negligence of this sign.



. . . . Note: Used together with the above "Warning" and "Attention", and you are requested to follow strictly



. . . . It is prohibited to do at any point.



. . . . Do not dismantle it without permission from the company.



. . . . Do not install it in a bathroom which is excessively wet or is easily immersed in water!



. . . . Do not touch with your hands!



. . . . Do not touch with wet hands!



. . . . Keep away from a combustible source.



. . . . Operate according to instructions!



. . . . Pull at the power plug!



. . . . Protective grounding

# avenue



Massa ITL-5001-EW  
Intelligent Toilet

## WARNING



This product shall be reliably grounded; otherwise, a fault or short circuit result an electric shock. When you are not sure, contact the electrical installation company.



Do not touch, insert or pull out the power plug with a wet hand or there will be a risk of electrical shock



Do not use a poor power socket or a damaged power plug or the poor contact or damage may cause electrical shock or a fire.

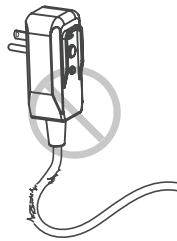

The power socket in use shall be within the specified range (AC110V) or a fire or electrical shock may occur easily.

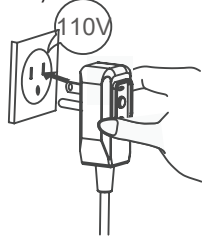

Do not pull, damage, bend, twist, stretch, roll, bundle, clamp or squeeze the power cable overly or bear load with it or damage of the power cable may cause electrical shock or a fire.



If soft part of the power cable is damaged, to prevent any danger, it shall be replaced. If care is not taken to replace the power cable a electrical shock or fire can result.



Do not put a lighted cigarette and other burning object into the intelligent toilet seat or a fire is easily to occur.



If the seat ring or the cover plate becomes damaged, to avoid danger. Be sure to pull off the power plug, close the water source and contact the local distributor for replacement. Otherwise, the danger of electrical shock or a fire may occur easily.



Occasionally pull out the power plug and wipe off any dust on the power plug with a dry cloth or a fire may be caused when insulation is poor.



A person with a disability shall be accompanied by someone when using the intelligent toilet to prevent any accidents.



Do not allow a child to play with this product or human injury may be resulted.



Only an authorized technician are allowed to work on the electrical components of this toilet. Failure to comply may result in personal injury or void the warranty.

# avenue



Massa ITL-5001-EW

Intelligent Toilet

## WARNING



For cleaning or maintenance of plastic parts, do not use unsuitable detergent (such as thick sulfuric acid, thick nitric acid, glacial acetic acid, carbon tetrachloride, chloroform, acetone, butanone, benzene, methylbenzene, phenol, methylphenol, dimethylformamide, methyl ether, soybean oil, acetate, 40% nitric acid, thick salt acid, 95% alcohol, gasoline, kerosene or brake oil, etc). Plastic parts may break and cause human injury, electrical shock or a fire.

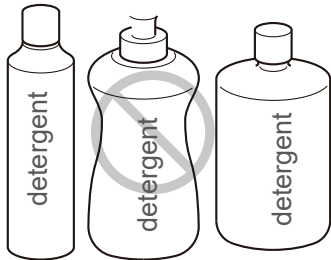

Do not use polluted water in operating this bidet seat.



Damage may occur to the bidet seat if it is not treated with care. Do not stand on the seat lid or cover plate.

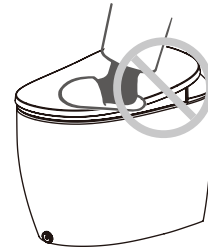

Do not insert a hand or other object into the warm air outlet, and do not cover the warm air outlet when the product is being used. Electrical shock, a fire or abnormal operation may be easily caused to result in human injury.

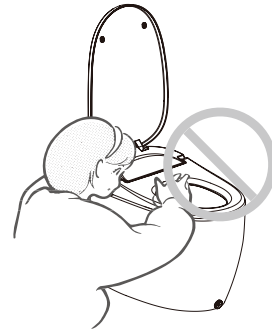

Do not allow any liquid near the warm air outlet or there may be a danger of electrical shock.



Keep remote control or the power plug away from water or wet surface. Potential danger of electrical shock or a fire.



Avoid installing this product in a bathroom which has excessive water. Do not spray water onto this product or rinse it with water. Potential danger of electrical shock or fire.



Use the battery correctly with the following method.

- Install the battery correctly according to proper poles.
- Replace the battery when it no longer has a power charge.
- Please recycle all exhausted batteries at a certified recycling centre.

# avenue



Massa ITL-5001-EW

Intelligent Toilet

## WARNING



Battery should be kept out of reach of an infant or child. Consult an doctor immediately:

- If the electrolyte solution is in contact with the body, rinse it with clean water in time.
- If the electrolyte solution enters eyes, do not rub the eye, rinse it with clean water.



When the battery is in use, do not do the following operations.

- Keep away from metal products (such as a necklace or a watch).
- Only use new batteries.

## ATTENTION



Do not use the high and medium levels of seat temperature, warm air/air temperature for extended periods. Long-time use of them may cause burning.



In use, keep the skin close to the sensor area within the seat ring, or this product may stop its wash or warm drying function. When a child is using it, it has difficulty to contact the sensor area.



Do not spray urine on the nozzle of the cleaner or dirt may be produced which will result in blockage.



Only use new braided water supply hoses when installing this toilet.



In case of sudden power failure, pull out the power plug and close the angle valve to prevent any water leakage or water leakage may be resulted and property loss may be caused.



Avoid direct sunshine or putting a heating device close to this product. May cause colour change.



To avoid the danger from wrong resetting of the thermal breaker, do not supply electricity with an external switch, such as through a timer and timing on-off circuit connecting to the universal part.



When the filter is dismantled, be sure to close the water supply angle valve. And when the filter is being installed, be sure to fasten it tightly or water leakage may easily occur.



Please unplug this unit if it won't be used for long periods of time. Damage may result from accumulated water inside the product and cause a fire or water leakage.



Do not expose this product to temperatures below 5°C. Freezing of any water inside the seat or bowl will damage this toilet.

# avenue



Massa ITL-5001-EW

Intelligent Toilet

## GROUNDING INSTRUCTIONS

This product must be grounded. In the event of an electrical short circuit, a grounded product reduces the risk of electric shock. This product is equipped with a cord having a grounded wire with a grounded plug. The plug must be plugged into an GFCI outlet that is properly installed and grounded.

**DANGER – Improper use of the plug can result in a risk of electric shock.**

Check with a licensed electrician or serviceman if the grounding instructions are not completely understood. Or if there is any doubt the product is properly grounded.

This product is for use on a nominal 110 V circuit, and has a grounded plug that looks like the electrical plug illustrated below.

## GROUNDING METHODS

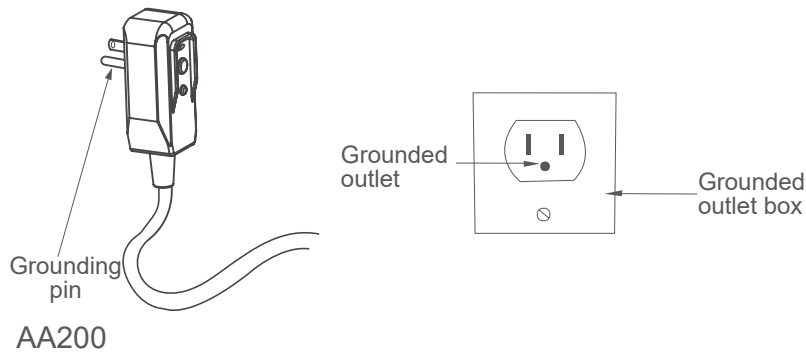

**\*WARNING: Risk of electric shock -**

**Connect only to a circuit that is protected by a ground-fault circuit-interrupter (GFCI).**

**This unit comes with an internal electrical leakage protection feature which will ground out minor electrical leakage.**



# avenue



Massa ITL-5001-EW

Intelligent Toilet

## IMPORTANT SAFEGUARDS

**When using electrical products, especially when children are present, basic safety precautions should always be followed, including the following:**

### **READ ALL INSTRUCTIONS BEFORE USING THIS TOILET**

**Full instructions and videos are located on our websites, please visit:**

**[avenuecanada.ca](http://avenuecanada.ca)**



### **DANGER– To reduce the risk of electrocution:**

1. Do not use while bathing.
2. Do not place or store product where it can fall or be pulled into a tub or sink.
3. Do not place in or drop into water or other liquid.
4. Do not touch a electrical product that has fallen into water.

### **WARNING– To reduce the risk of burns, electrocution, fire, or injury;**

1. Close supervision is necessary when this product is used by, on, or near children.
2. Use this product only for its intended use as described in this manual. Do not use attachments not recommended by the manufacturer.
3. Never operate this product if it has a damaged cord or plug, if it is not working properly, if it has been dropped or damaged, or dropped into water.

### **Return the product to a service center for examination and repair.**

1. Keep the power cord away from heated surfaces.
2. Never block the air openings of the product or place it on a soft surface, such as a bed or couch, where the air openings may be blocked. Keep the air openings free of lint, hair, and the like.
3. Never use while sleeping or drowsy.
4. Never drop or insert any object into any opening or hose.
5. Do not use outdoors or operate where aerosol (spray) products are being used or where oxygen is being administered.
6. Connect this product to a properly grounded outlet only. See Grounding Instructions.

SAVE THESE INSTRUCTIONS

# avenue



Massa ITL-5001-EW  
Intelligent Toilet

## HARDWARE AND PARTS LIST

**01** Intelligent Toilet



**02** HE50 Filter (Part # PB-HE50-WATERFILTER)

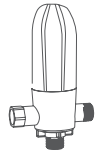

**03** Wax Ring



**04** Remote Control Assembly



**05** Operating instruction and other prints

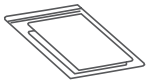

**06** Connector

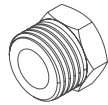

**08** Floor Bolts x2

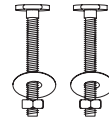

## TOOLS

**01** Percussion drill (with a 6mm drilling bit)

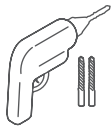

**02** Teflon tape



**03** Utility knife

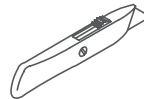

**04** Marking pen



**05** 23-26mm Wrench



**06** Philips or slot type screwdriver

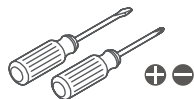

**07** Tape measure



**08** Measuring cup



- The pictures for the above articles are only for reference.
- Batteries are not supplied. 2x AAA required for remote control unit.

# avenue



Massa ITL-5001-EW  
Intelligent Toilet

## CONFIRM PRIOR TO INSTALLATION

### Water Requirements

- Minimum dynamic working pressure is 35 psi (no less than 5.3 gal/min at flowing), and maximum static water pressure is 80 psi (in motionless state). Minimum water pressure required for basic function performance.

### Key point for measurement of minimum water pressure

This method can be used if you have no water pressure measuring apparatus

### Key point to consider

Please note where well water is being used; a main water filter system is highly recommended to ensure the best results when using this product. Additionally, the added minerals associated with well water may result in the filter requiring to be changed more frequently. To purchase or subscribe to our filter replacement program please visit : <https://fgiparts.ca/product/pb-he50-waterfilter>

### Open the water supply angle valve

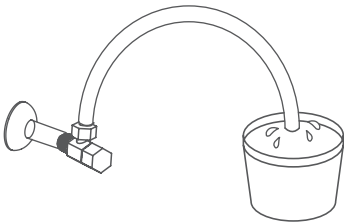

Measure flow-out water for 10 seconds, if water volume exceeds 0.9 gal, the water pressure meets the installation indexes of intelligent toilet.

Tools for use: stopwatch and measuring cup

## CONFIRMATION OF DIMENSION FIGURE

Unit: inches

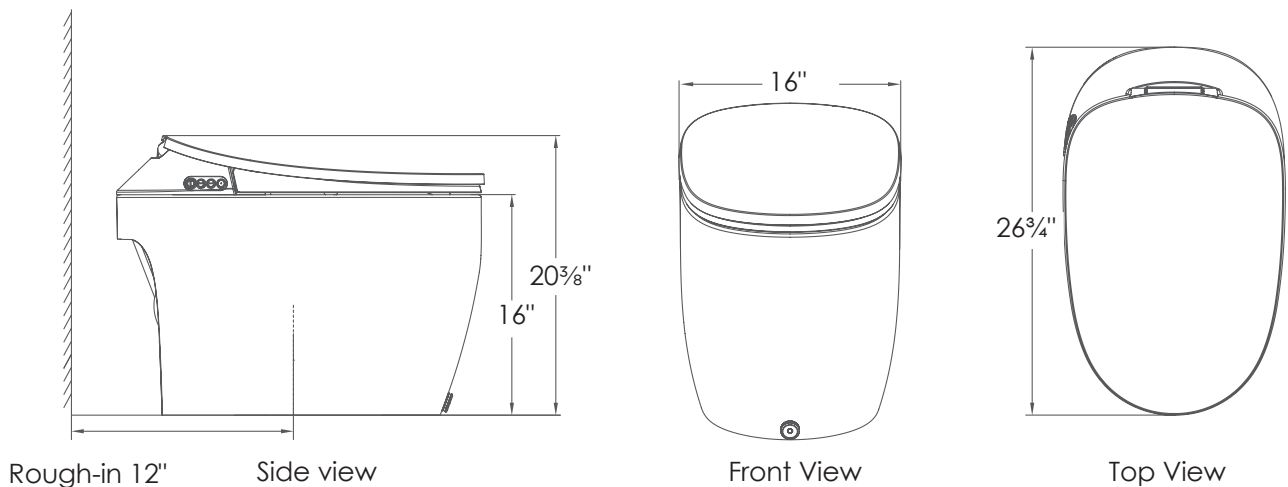

\*We reserve the right to change the dimension marked in the figure at any time without prior notice.

# avenue



Massa ITL-5001-EW

Intelligent Toilet

## INSTALLATION INSTRUCTIONS

**01** Lift the packaging upwards to expose the toilet

According to the following diagrams, put the accessories aside for later use, and then lift the packaging upwards to allow for the toilet to be exposed. (F1)

F1

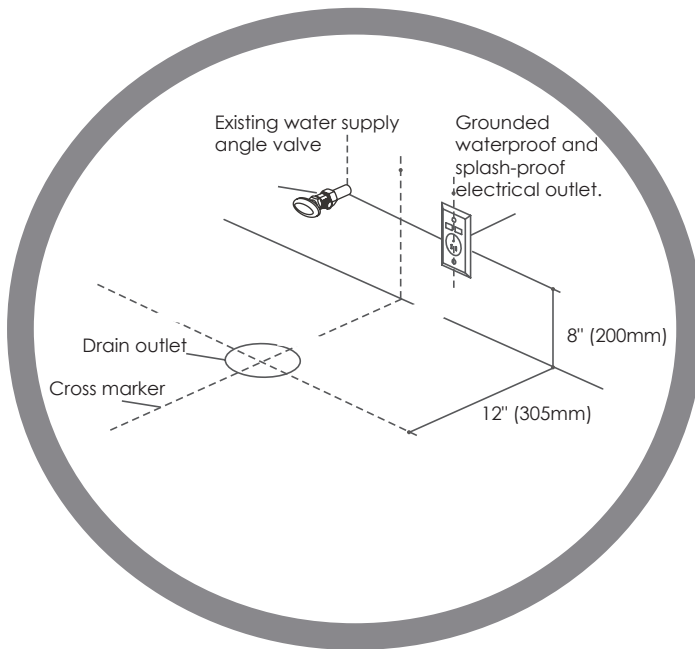
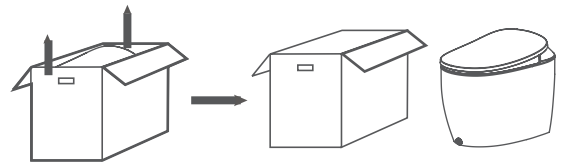

F2

**02**

Draw a cross marker on the drain outlet on the ground  
Clean the floor and wipe off any excess dust or dirt (F2).  
Failure to install on a cleaned surface will affect the quality of installation.

**03** Install the new flange to the drain outlet or use existing one and draw a cross line with an erasable marker as a reference line for installing the toilet (F3).

F3

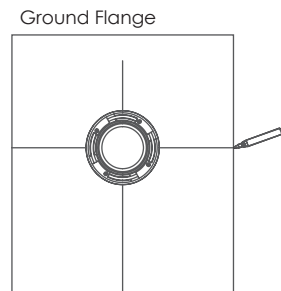

# avenue



Massa ITL-5001-EW

Intelligent Toilet

## INSTALLATION INSTRUCTIONS

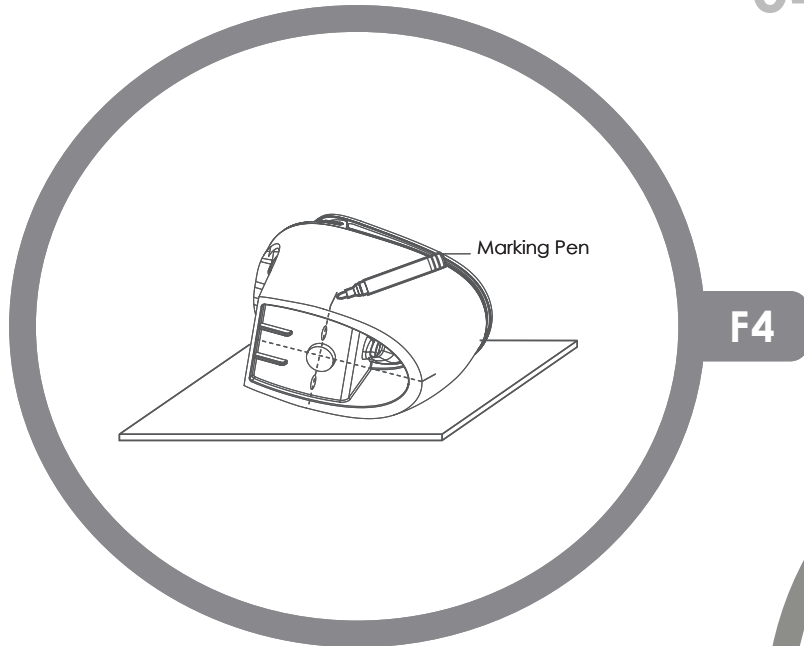

04

Install the intelligent toilet bottom flange anchor screw

Turn the ceramic body over laterally and place on a prepared foam surface (F4).

By visual measurement, draw a line on one lateral side of the ceramic body point of the drain outlet perpendicular to the plane against the central of ceramic bottom, and the same for the other lateral side, and draw a line perpendicular to the floor from the front central point of ceramic body.

F4

05 Install the wax ring and brass floor bolts onto the floor flange

Center and press the wax ring on the floor flange. Insert the 2 brass floor bolts flat head thru the appropriate slot in the floor flange. Use the provided plastic floor bolt washer to secure the floor bolts on the floor flange. Brass bolts should remain vertical (F5A + F5B).

F5A

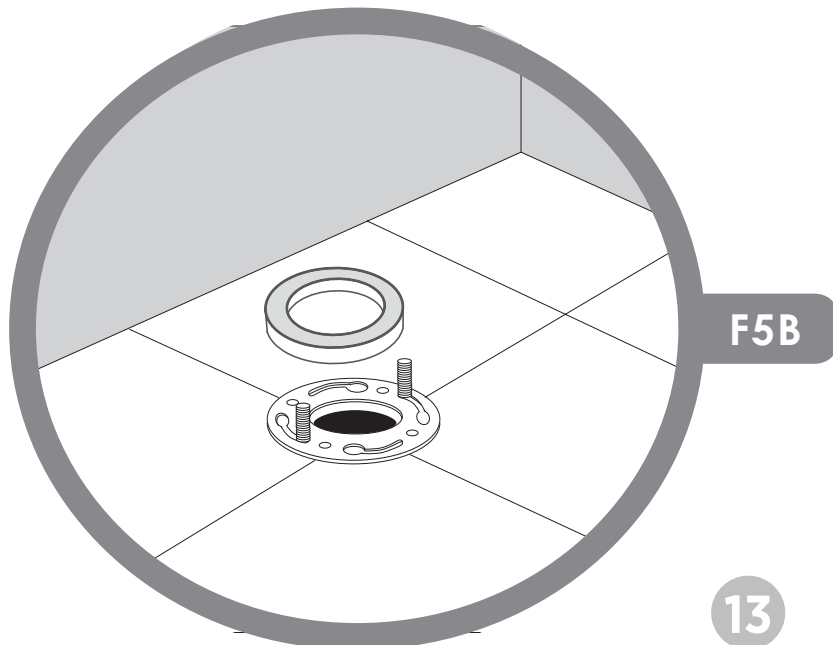
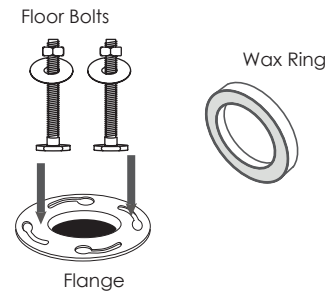

13

# avenue



Massa ITL-5001-EW

Intelligent Toilet

## INSTALLATION INSTRUCTIONS

### 06 Preparing the toilet seat for toilet bowl installation

The toilet seat is preinstalled by the factory. In order to access the floor bolts to secure the bowl to the floor flange the toilet seat bolts need to be removed (F6A + F6B). Remove both screw covers with slot screwdriver and remove two fixed screws with cross screwdriver. Then unscrew plastic nut at back of the toilet bowl. Lift the seat and move it forward so as to leave space to lock the floor bolts.

DO NOT remove the seat entirely, simply move it forward to gain access to the back of the toilet bowl. (F6C)

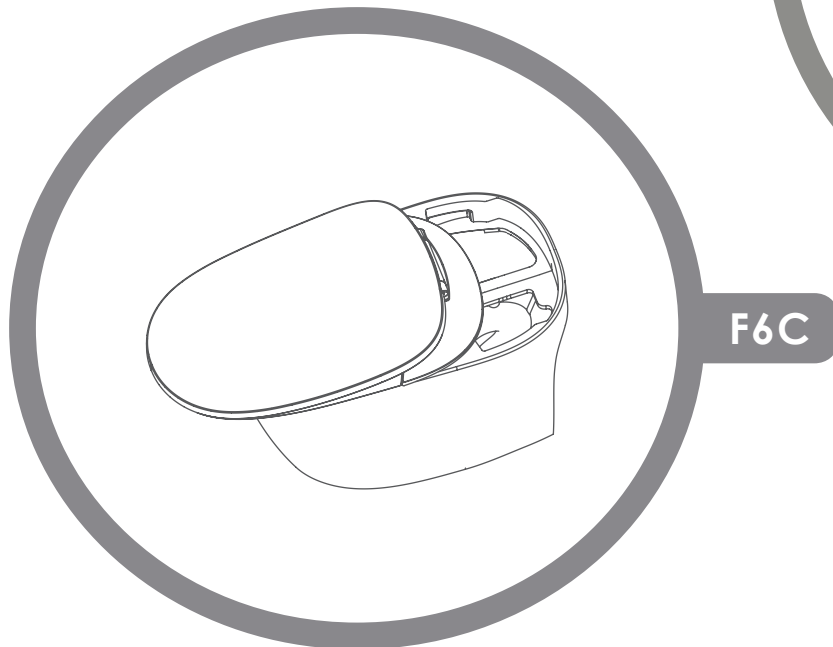
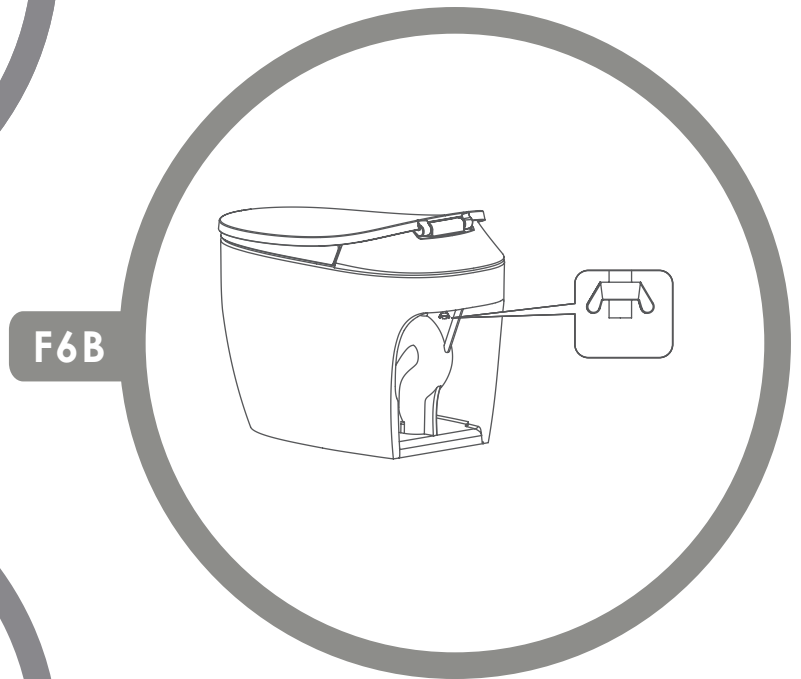
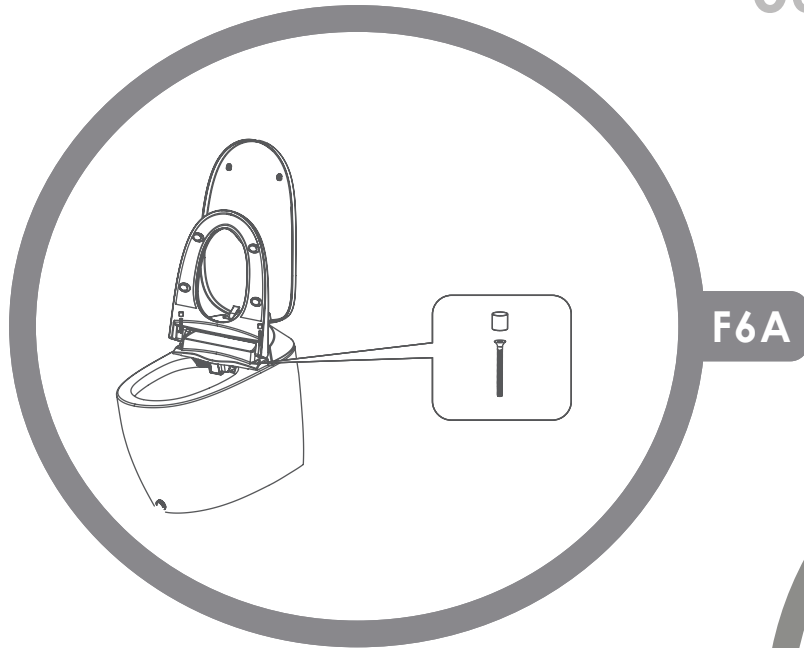

# avenue



Massa ITL-5001-EW

Intelligent Toilet

## INSTALLATION INSTRUCTIONS

### 07 Installing the toilet bowl onto floor flange

Two people to lift the toilet bowl, slowly lower the bowl onto the floor flange use the guide marking as the toilet reference. Making sure the floor bolts on the floor flange completely come through bolt opening on the bottom of toilet bowl by viewing from the back of the seat. Next, press down the toilet bowl firmly onto the floor so the wax ring can create the full seal. Lastly, screw down the nuts on the floor bolts with a wrench to secure the toilet bowl on the floor from the opening behind the back of the seat.

**Caution:** Do not move the toilet bowl around once the toilet bowl is in position. It can damage the wax ring seal and result in water leakage.

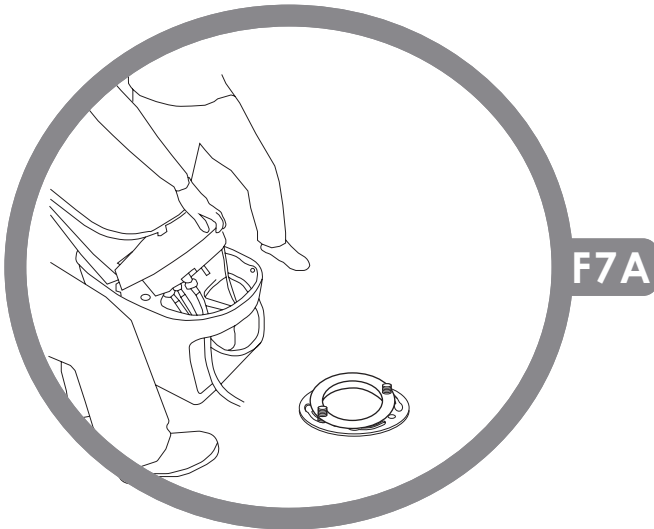

F7A

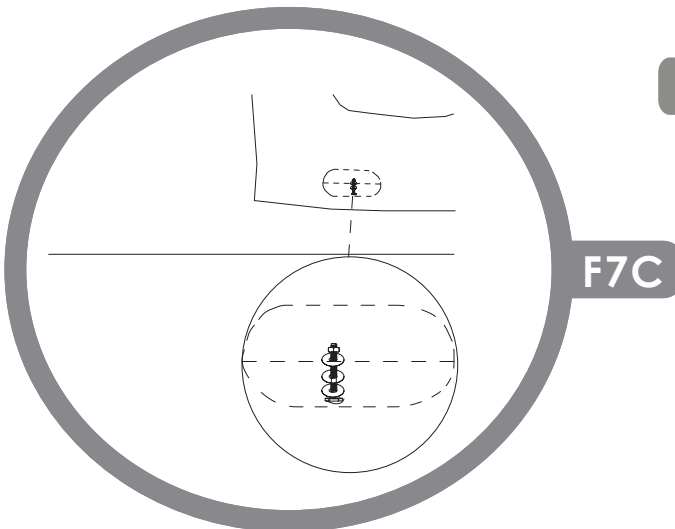

F7C

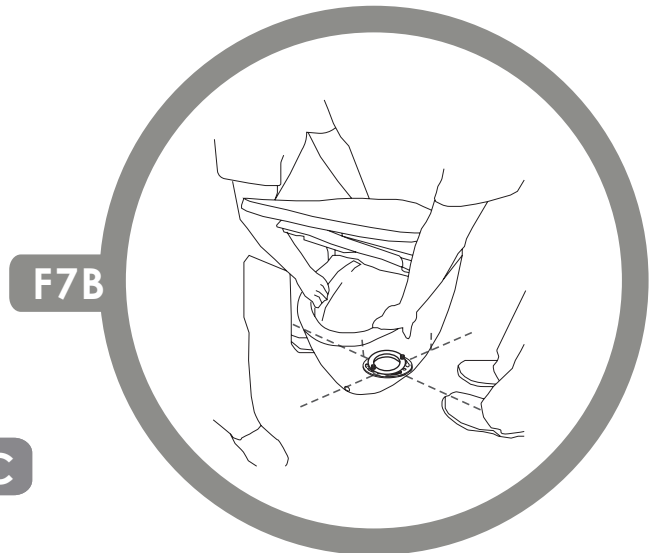

F7B



F7D

# avenue



Massa ITL-5001-EW

Intelligent Toilet

## INSTALLATION INSTRUCTIONS

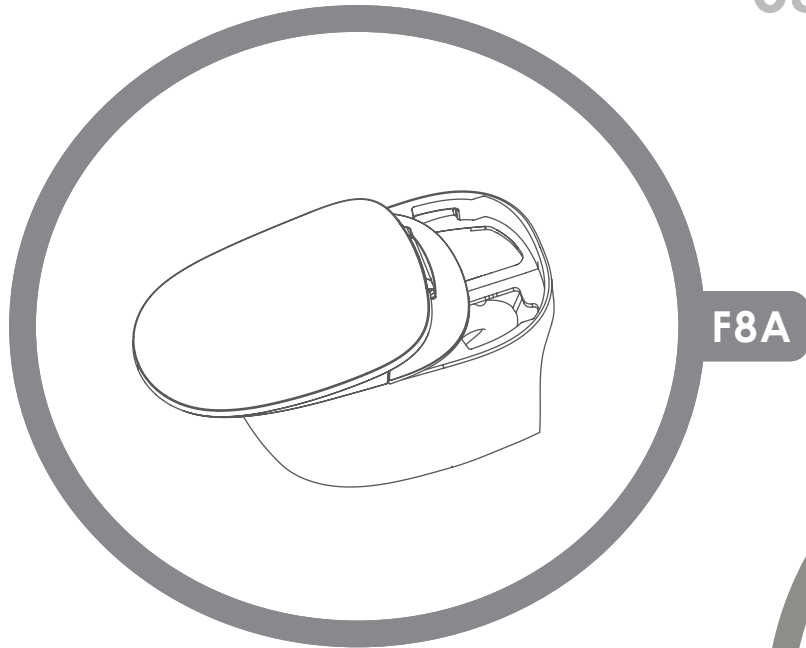

F8A

08

Re-attach toilet seat

Shift toilet seat back into position over bowl and align bolt holes in seat to appropriate holes in top of bowl. (as reverse steps 6)

Reinstall 2 bolts and plastic covers on top surface of the toilet seat.

Re-install 1 plastic nut to the underside of seat securing the seat to the bowl.

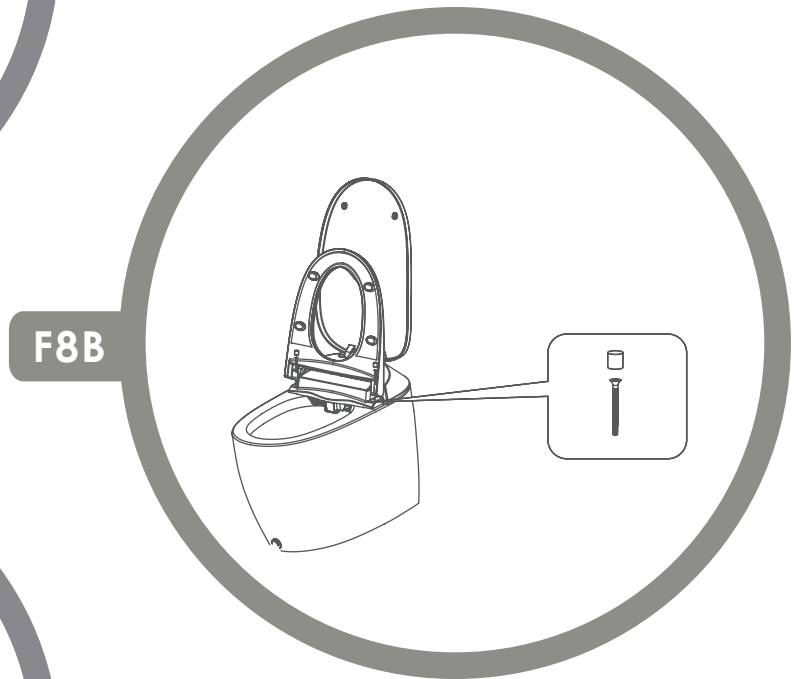

F8B

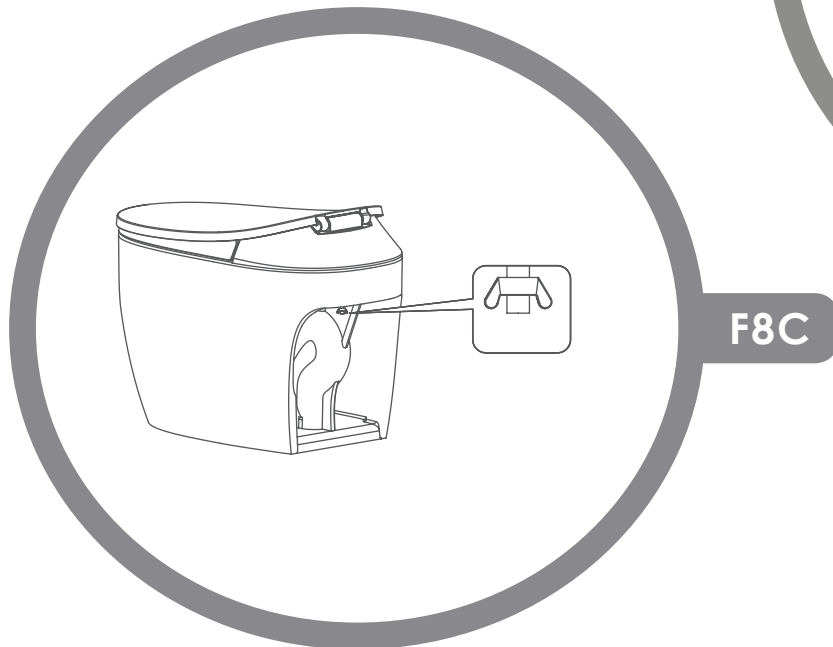

F8C



# avenue



Massa ITL-5001-EW

Intelligent Toilet

## INSTALLATION INSTRUCTIONS

**09** Connecting the water filter to shut off valve and connecting braided water supply hoses.

**Full Water Filter Mechanism: PB-TL5001-PART 50**

**Water Filter Cartridge: PB-HE50-WATERFILTER**

With the 3/8" male connection facing to the right, apply Teflon tape and screw on adapter (supplied). (F9A + F9B)

Connect water filter to male thread on adapter (apply Teflon tape to male threads). (F9C)

Connect braided supply tubes to water filter male connections. (F9D)

- Seat water supply hose to bottom of water filter
- Toilet water supply hose to right side of water filter

**Note: Use Teflon Tape on all threaded connections to insure a water tight seal.**

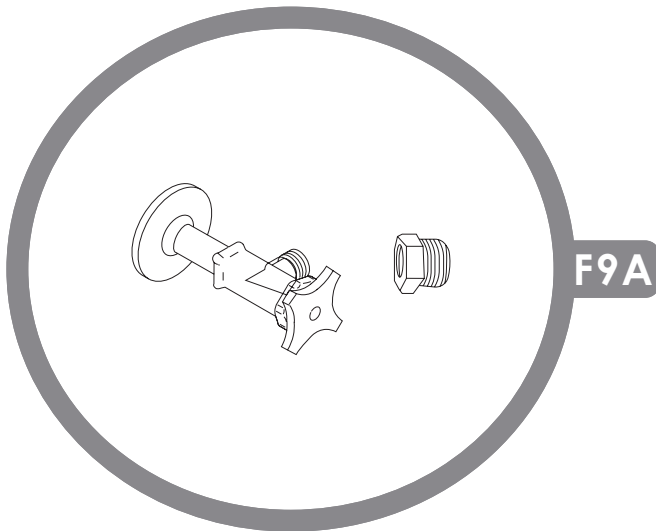

F9A

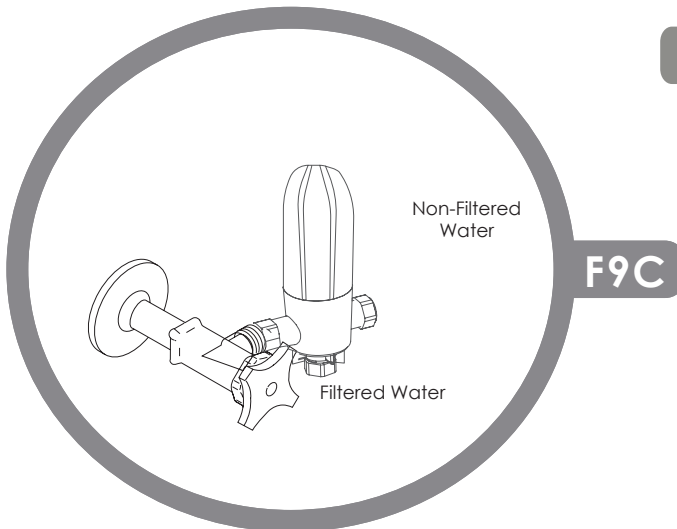

F9C

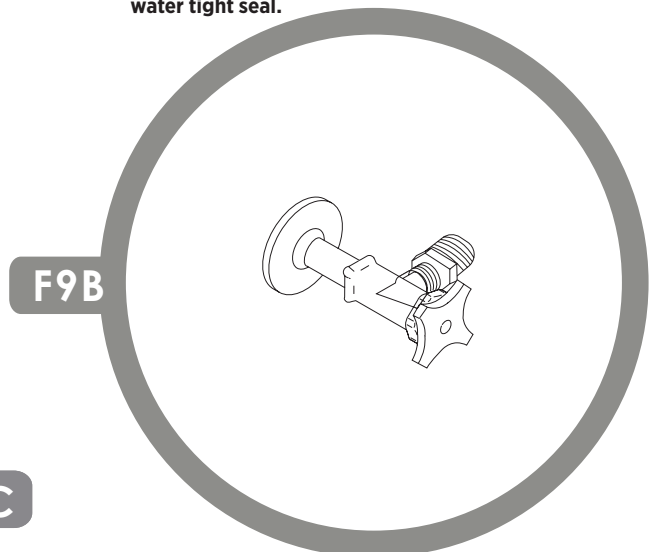

F9B

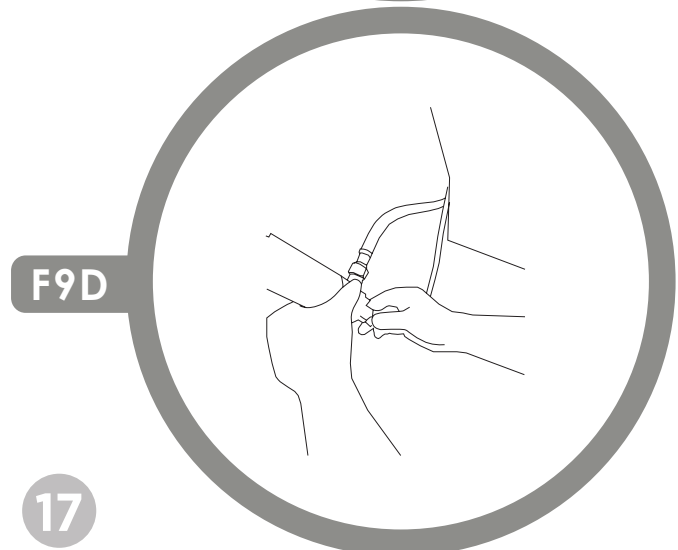

F9D

# avenue



Massa ITL-5001-EW  
Intelligent Toilet

## INSTALLATION INSTRUCTIONS

10

Turn on water at shut off valve

Turn valve into the ON position and check for any water leaks at hose connections.

If any leaks appear tighten connection until leaking stops. (F10)

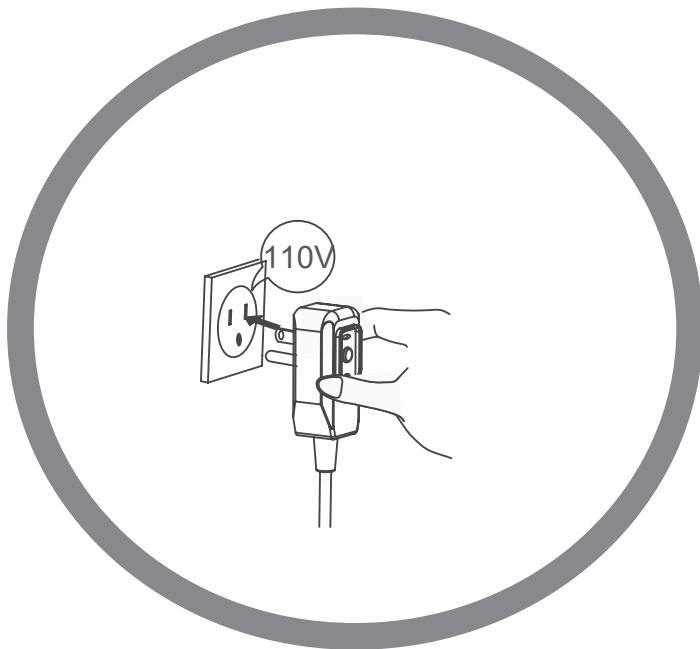

F11

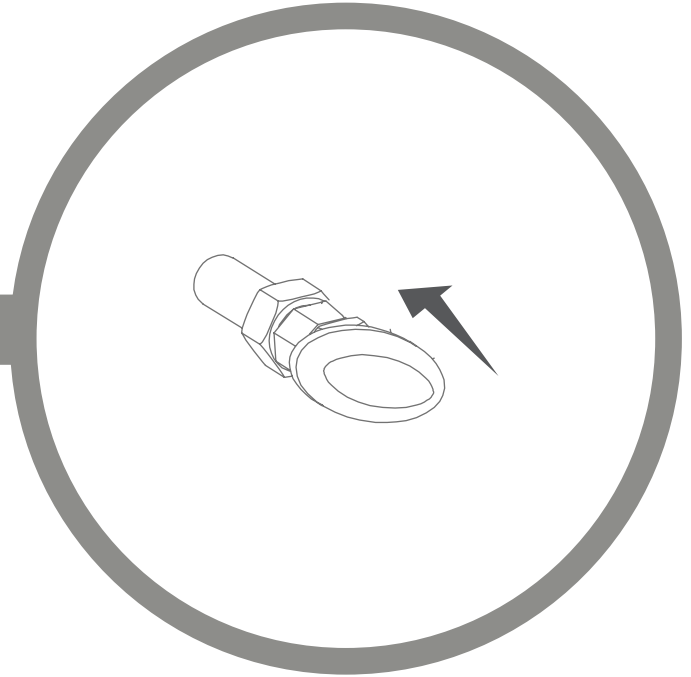

F10

11

Plug in the gfci power cord to the electrical outlet

To confirm power is being supplied to the toilet, the power plug indicator will be on and the Foot flushing mechanism will illuminate a blue LED light.

If LED light does not turn blue press the RESET button on the GFCI Plug. (F11)

12

Mount the remote controller on the wall

Use the supplied screws and expansions to mount the bracket on the wall.

Open back cover of remote controller and load new AAA battery x2.

Put the remote controller on the bracket. (F12)

### INSTALLATION STEPS OF MOUNTING BRACKET

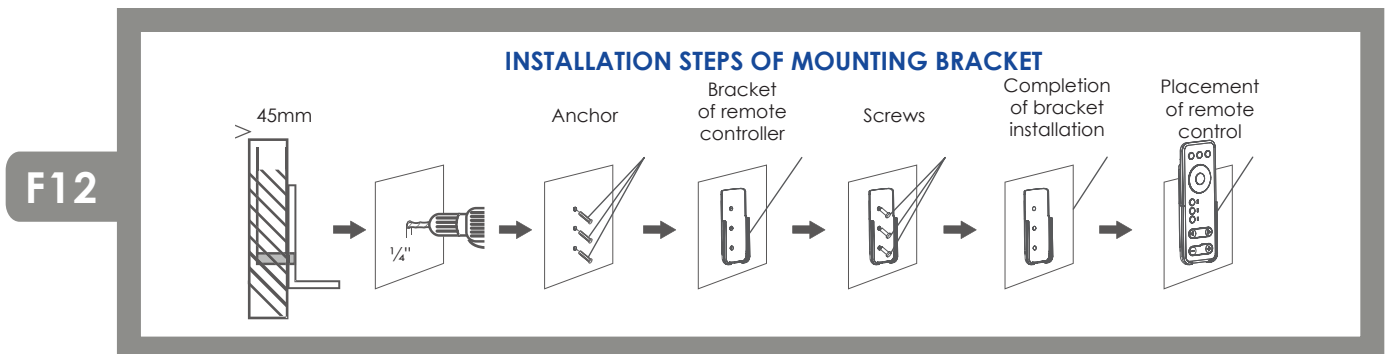

F12

# avenue



Massa ITL-5001-EW

Intelligent Toilet

## INSTALLATION INSTRUCTIONS

### 13

#### CONGRATULATIONS!

The installation of the Massa Intelligent toilet is complete.

Please keep the Sale Receipt and these instructions for future reference and important information.

## TRIAL RUN

(TRY IF THE KEYS ON THE REMOTE CONTROL AND THE LATERAL BUTTONS ON THE TOILET TO SEE THAT IT IS WORKING NORMALLY.)

Are functions of the product normal? (F13)

Are posterior wash and feminine wash (wash strength adjustment and nozzle position adjustment), adjustment of warm air/air temperature, water temperature/seat temperature, cleaning of nozzle and remote control normal? The above actions should be checked.

Test of operations of posterior wash process: Put a hand on the sensing area, press the movement key for posterior wash on the remote control, cover the front end of the cleaner to block the cleaning water spray.

F13

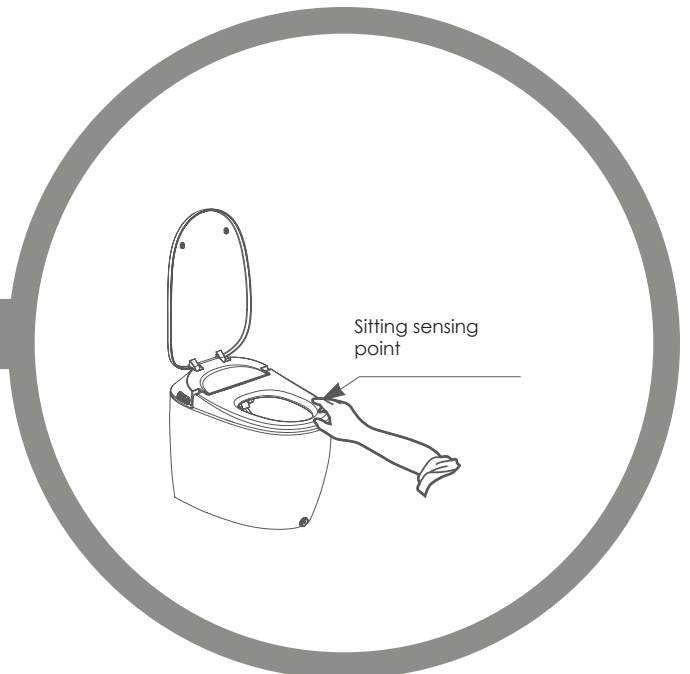

# avenue



Massa ITL-5001-EW  
Intelligent Toilet

## REMOTE CONTROL CODE MATCHING PROCEDURE

Code matching of the remote control has been completed during the production of the product. In case the remote is not working, match the codes as per below:

Unplug the power cord, hold on the stop key until the level indicator flickers and then loosen it (F14A).

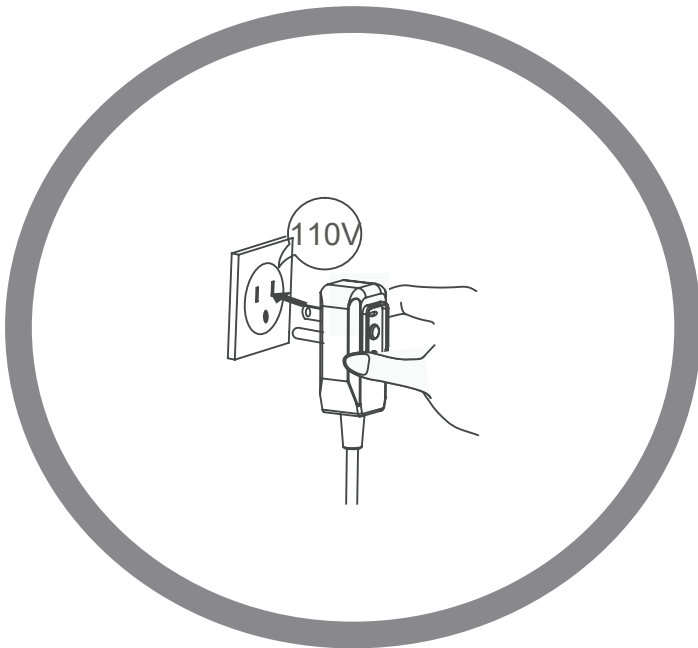

F14B

The level indicator stops flickering and is on (F14C).

Code matching is complete.

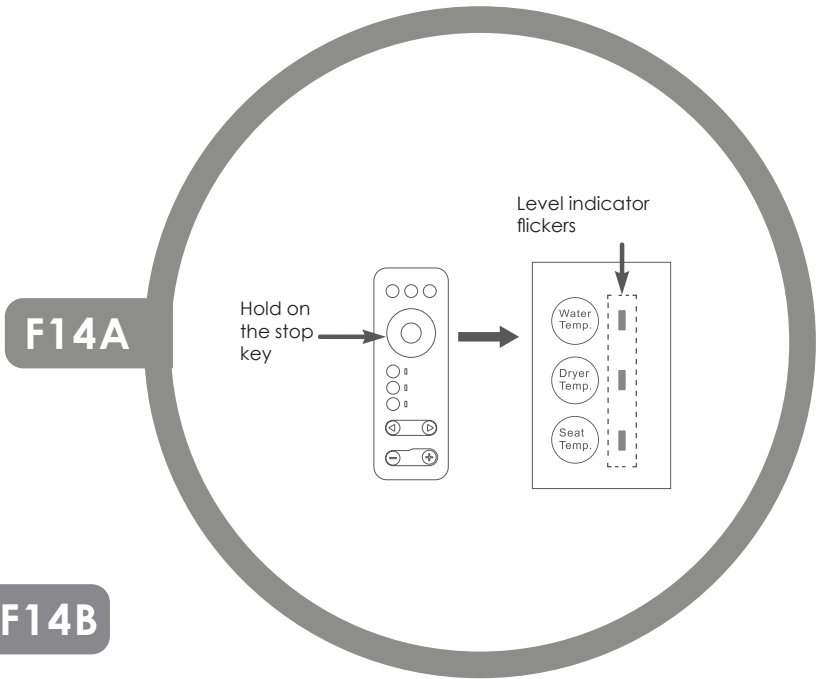

F14A

Put the remote controller close to the product and insert the plug (F14B).

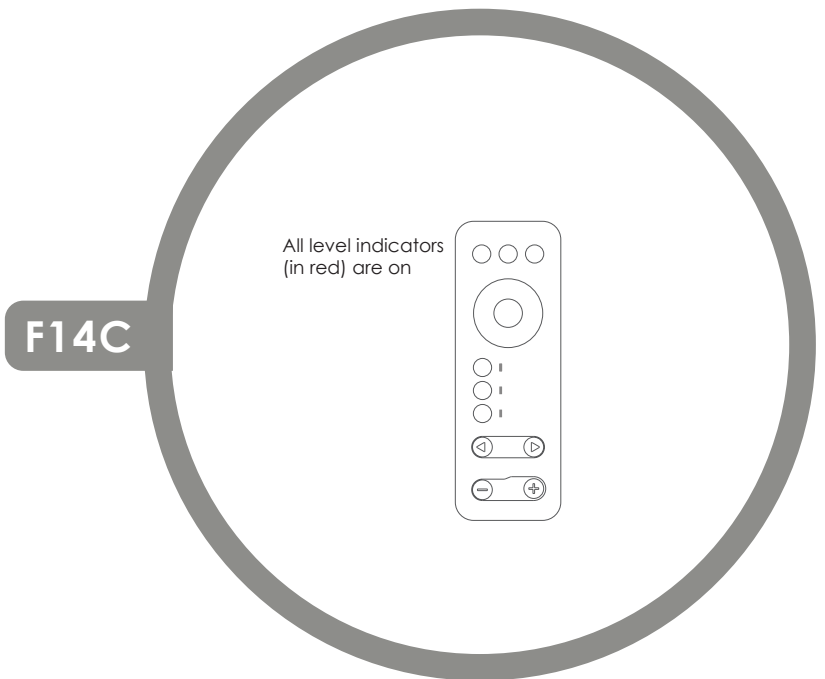

F14C

# avenue



Massa ITL-5001-EW  
Intelligent Toilet

## FUNCTIONS FOR USE

The Intelligent toilet automatically turns on when it senses body electrostatic induction being applied to the seat ring. The wash functions and warm air function will not work unless the body sensor on the seat ring detects body electrostatic induction (F15).

### BIDET

Press "Bidet" key.

Water flow for wash is jetted out of the front end of the nozzle, and the private part of a female is washed. Press it again to turn off oscillating.

### POSTERIOR

Press "Posterior" key.

Water flow for wash is jetted out of the front end of the nozzle and washes the posterior. Press it again to turn off oscillating cleaning.

### FLUSH

Press "Flush" key.

Activate a flush function.

### STOP

Press "Stop" key.

Stops all washing and drying function currently running.

For "Posterior" and "Bidet" wash, there's an auto-stop function 4 minutes later.

F15

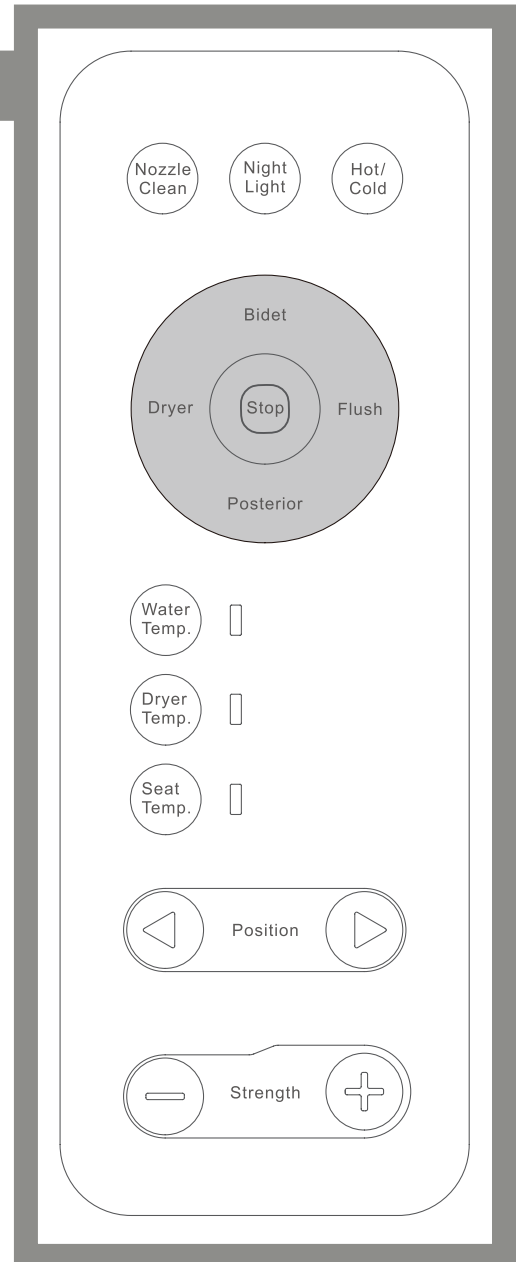

# avenue



Massa ITL-5001-EW  
Intelligent Toilet

## FUNCTIONS FOR USE

### HOT/COLD

Press "Hot/Cold" key, and Hot/Cold function will be enabled or disabled.

In wash mode, press Hot/Cold key to change cold and warm water wash alternately.

This function can only be used in washing mode.

### DRYER

Press "Dryer" for drying washed area.

Press dryer for drying washed area. When it is switched to warm-air temperature, press "Dryer Temp." key, current temperature level will be displayed when the key is pressed for the first time. When it is pressed again, it will be switch to temperature level, and proper temperature can be set.

When the key is pressed, display indicator is switched among [Off (display indicator is off)], [Low level (display indicator is in blue)], [Middle level (display indicator is in purple)], and [High level (display indicator is in red)].

Warm air has a automatic stop function 4 minutes later.

### Reference

After washing, wipe off the excess water with tissue paper, or press the Dryer key for faster drying.

### Warning

Use the "Low Level" temperature setting for children or people with sensitive skin.

F16

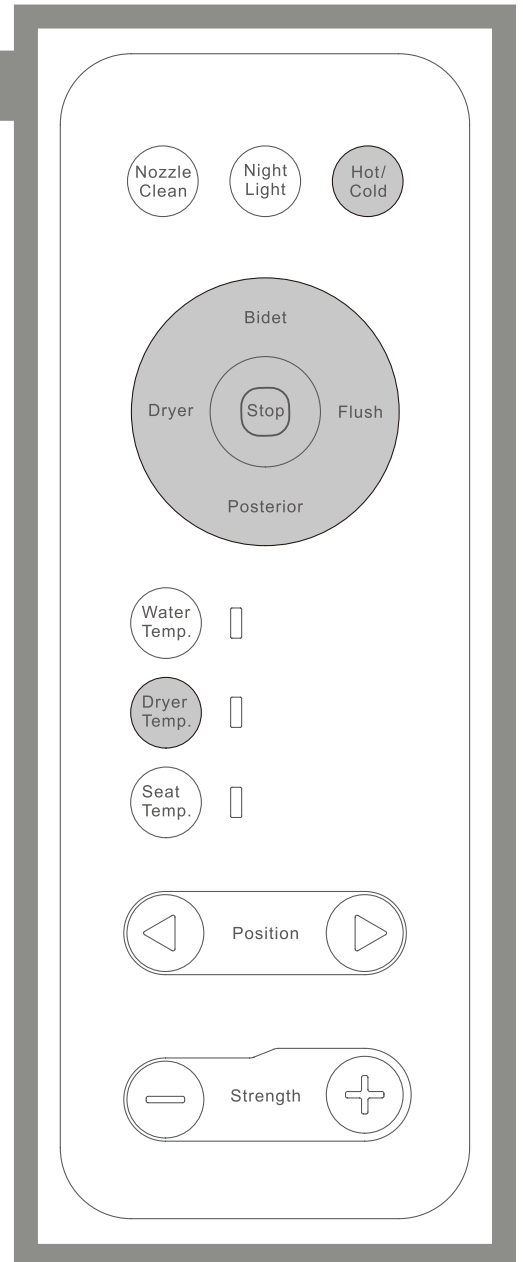

# avenue



Massa ITL-5001-EW  
Intelligent Toilet

## FUNCTIONS FOR USE

### WATER TEMPERATURE

Press the "Water Temp" key to adjust water temperature.

The current temperature level will be displayed when the key is pressed for the first time. Pressing a second time will adjust the water temperature. Continue pressing until the desired temperature is achieved.

Temperature sequence is off, low (blue), medium (purple), and high (red).

### SEAT TEMPERATURE

Press "Seat Temp." key to adjust seat ring temperature.

Current temperature level will be displayed when the key is pressed for the first time. Pressing a second time will adjust the water temperature. Continue pressing until the desired temperature is achieved.

Temperature sequence is off, low (blue), medium (purple), and high (red).

### Warning

Use the "Low Level" temperature setting for children or people with sensitive skin.

F17

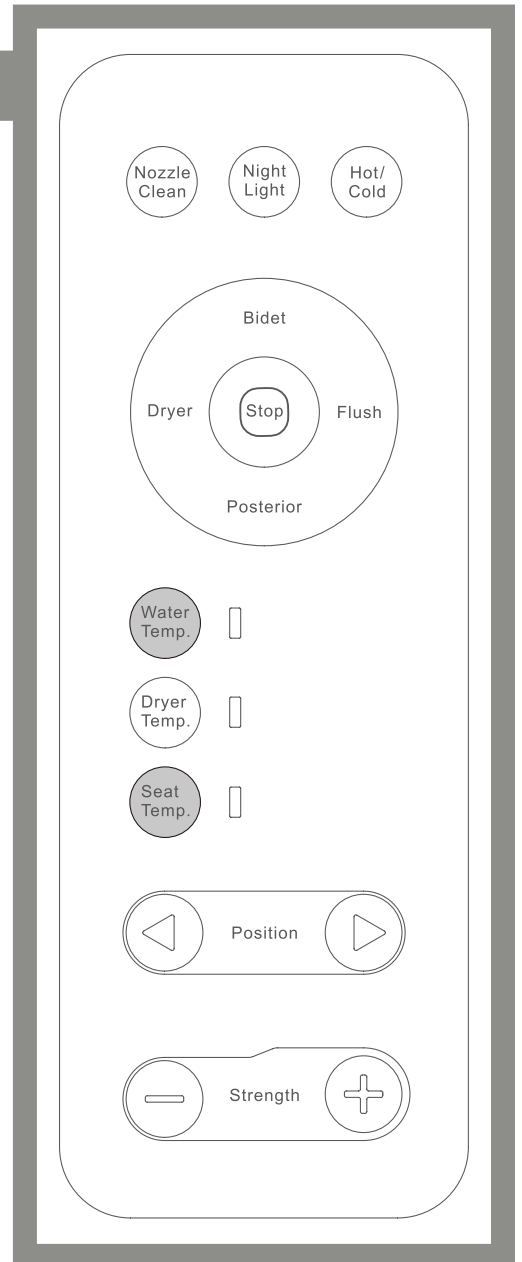

# avenue



Massa ITL-5001-EW  
Intelligent Toilet

## FUNCTIONS FOR USE

### NOZZLE CLEAN

Press "Nozzle Clean" key. (Dual functions)

The nozzle sticks out for manual cleaning. This function can only be used when no body part or other objects are not in contact with the seat ring sensing area.

When you are sitting on the seat, press "Nozzle Clean key" to turn on/off the wash with air bubbles.

This function can only be in wash mode.

### NIGHT LIGHT

Press "Night light" key.

Night light will only turn on or off.

### SPRAY POSITION

Press "Position" key.

Position can be adjusted within five levels (high to low levels).

### SPRAY STRENGTH

To change wash strength, press "+" or "-" key.

Washing strength can be adjusted for 3 levels. Press key until water flow strength is found.

### Note

When water pressure is low, jet spray will be reduced resulting in a weak washing strength. Please increase spray strength (see above).

To reduce water splash please sit as far back on the toilet seat as comfortably possible.

F18

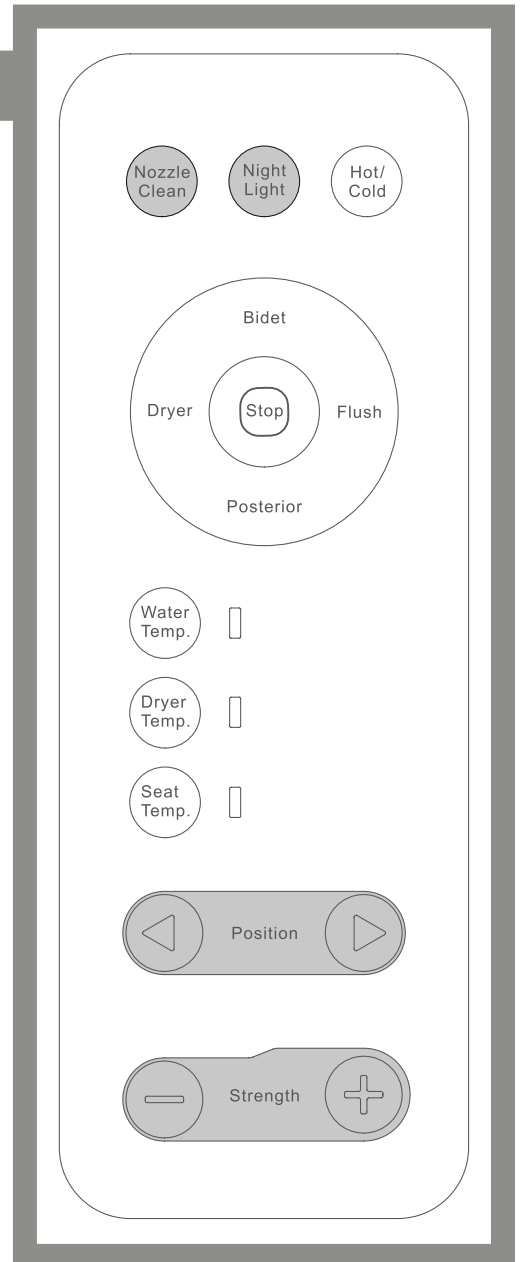



# avenue



Massa ITL-5001-EW  
Intelligent Toilet

## SETTINGS OF OTHER FUNCTIONS

### POWER/STOP

Press "Power/Stop" key to turn **on** the device. Hold "Power/Stop" key to turn **off** the device.

Water spray wash function can be turned off at any time by pressing Power/Stop button.

### POSTERIOR

Press "Posterior" key.

When a person is seated and sensed, press "Posterior" key, the functions of posterior wash (1.5 min) and Air Dryer (4 min) will be started in sequence. Press the key again in the washing process to fast forward to Air Dryer.

### BIDET

Press "Bidet" key.

The Bidet wash spray will become active when the seat senses a body and the Bidet function key is pressed. There is a wash spray (1.5 min) followed by a warm air dry cycle (4 min). To skip the wash setting press the Bidet function twice.

### MANUAL FLUSH

Press "Flush" key.

Toilet will be flushed.

### AUTOMATIC FLUSH

The human body leaves the seat ring sensing area.

When a person leaves the seat after being seated, the device will flush automatically.

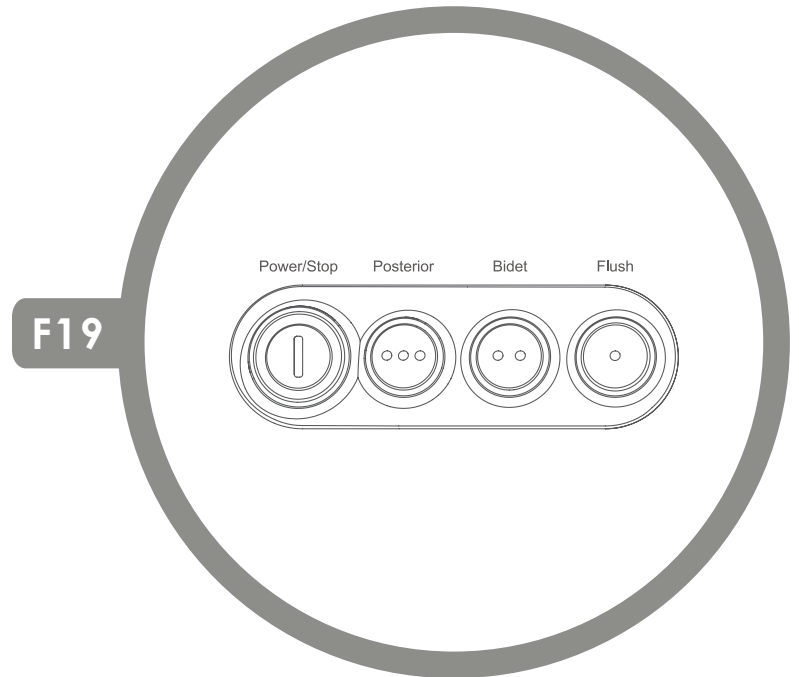

# avenue



Massa ITL-5001-EW  
Intelligent Toilet

## SETTINGS OF OTHER FUNCTIONS

### WARM-AIR FLUSH

Press "Dryer" key (F20).

Warm air function will be enabled.

F20

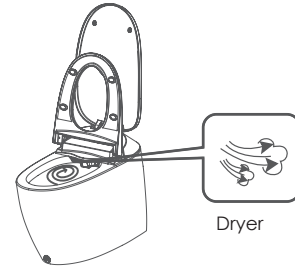

### UV STERILIZATION

Radiate at the nozzle (F21).

After using the bidet seat, the UV sterilization will automatically start and stop in 3 minutes. when UV is in function, the indicator will be on in icy blue. The indicator will be off when the function is stop

F21

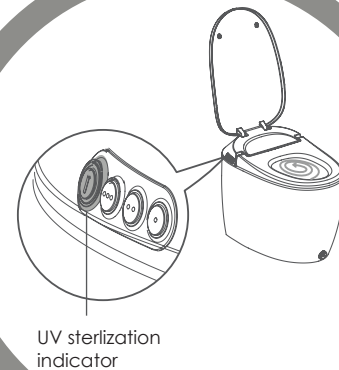

### FOOT FLUSH FUNCTION

Move closely to the toilet, lightly touch with your foot to activate the flush function (F22).

When seating on the toilet, the function will not start.

Do not touch the button multiple times or damage could occur.

During the flush process the Posterior and Bidet wash function cannot be used.

### MORE PERSONALIZED CONSIDERATE DESIGN

Soft Close Toilet Seat: Soft close function enables seat ring and cover plate to rise and fall slowly.

Water Purification: A dedicated filter is equipped for purifying water source and ensuring sanitation of the user during wash functions.

Standby Mode: This product will turn off automatically if not used within a 24 hour period.

F22



# avenue



Massa ITL-5001-EW  
Intelligent Toilet

## METHODS FOR CLEANING AND MAINTENANCE

To ensure normal use of the product, please clean and maintain the product regularly.

### Note

Disconnect the power source prior to maintenance, close water supply angle valve and turn off water supply.

Rinsing this product with water is prohibited in the course of maintenance.

### Maintenance of Water Filter (Part # PB-HE50-WATERFILTER)

Keep area around water filter clear and away from harsh cleaners.

Do not install water filter next to any heat source.

Do not expose to long periods of intense sunshine or allow water filter to freeze once installed.

Replace water filter every 6 months. Contact our Customer Service team on details for water filter requirements. (When filter elements become black or brownish).

Turn off water supply at shut off valve if intelligent toilet won't be used for an extended period of time (ie: one month).

**It is recommended that the filter be replaced on a 6-month basis.**

**Please contact us to purchase your replacement water filter.**

In USA - 1-888-620-3667

In Canada - [www.fgiparts.ca](http://www.fgiparts.ca)

### Common Faults

#### Symptoms

No water runs out

#### Solutions

Open the water source

Open the water supply angle valve

Tighten all connections

Water flow is reduced

Replace the water filter cartridge

The device is water leaking

Check wax ring was installed properly. Replace wax ring if damaged.

Install the new filter

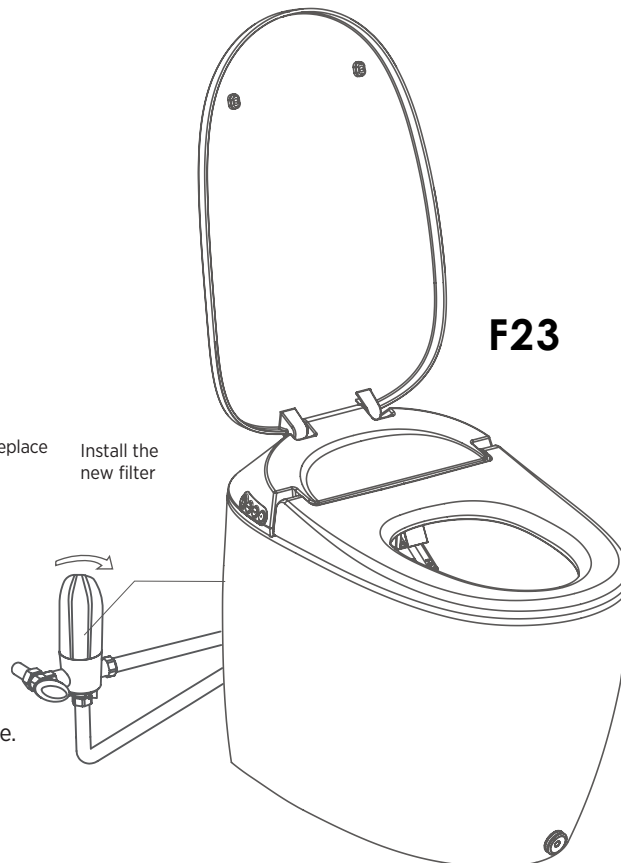
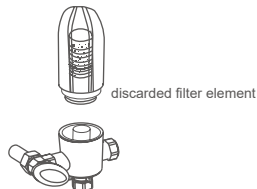
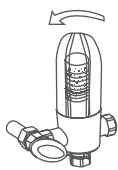

Remove the expired filter cartridge by rotating counterclockwise.

Install a new filter cartridge. Turn clockwise to lock it in place

# avenue



Massa ITL-5001-EW

Intelligent Toilet

## METHODS FOR CLEANING AND MAINTENANCE

### Method of Cleaning and Maintenance of Plastic Products and Ceramic Body (F24)

When any dust or dirt is attached to the product, wipe the product a soft wet cloth.

The ceramic bowl can be cleaned with a soft brush, cloth or wet sponge with detergent.

Do not use harsh chemicals or detergent on any part of the intelligent toilet.

F24

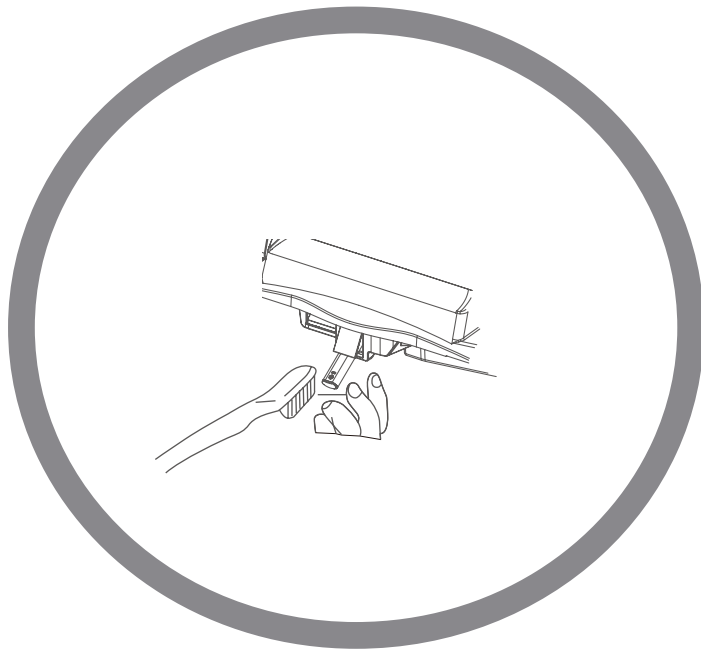
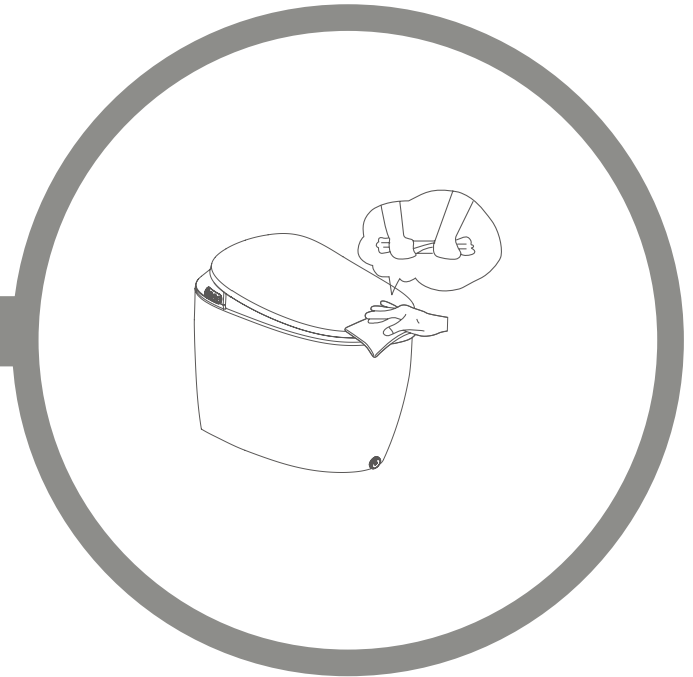

F25

### Cleaning and Maintenance of Nozzle (F25)

In the power-on and seat-leaving state, press the nozzle cleaning key on the remote controller, and the nozzle will stick out automatically. If there's any dirt on the nozzle hole, support the cleaner gently with one hand, and clean it with a clean unused toothbrush.

Do not clean with excessive force, or the nozzle may be damaged.

The sprinkler head can be removed to clean the internal scale and impurities. Do not push too hard when removing. Hold the cleaning rod with one hand and the sprinkler head with the other. When installing, keep the outlet hole up and complete the installation accordingly.

# avenue



Massa ITL-5001-EW

Intelligent Toilet

## TROUBLE-SHOOTING

Power switch, posterior wash, bidet wash and warm-air/air temperature, etc.

### When any issue is found

If issues arise, read the list below first for trouble-shooting tips. If the issues do not resolve, please contact our customer service team at the contacts below, or visit our website for more troubleshooting help.

### Power Switch

| Symptom                   | Analysis of Issue  | Solution  |
|---------------------------|--|---|
| The product does not work | Check if the power switch/ socket is loose                                       | Check the circuit is active.  |
|                           | Check if power is leaked (indicator for power leakage protective plug is not on) | Pull out the power plug from the socket, and insert it again. Press the reset switch for the power leakage protective switch, if it does not work yet, remove and replace the power plug. |

### Posterior and Bidet wash

| Symptom                             | Analysis of Issue   | Solution   |
|-------------------------------------|---|--|
| No water comes out of the nozzle    | Check if water supply is stopped  | Wait for recovery of water supply  |
|                                     | Check if the angle valve is closed  | Open the angle valve   |
|                                     | Check if the water intake filter is blocked                                   | Replace the filter   |
|                                     | Check if the water intake pipe is folded                                      | Remove folding of the water intake pipe  |
| Wash strength is weak               | Check if water wash pressure is set at the lowest level                       | Adjust water pressure as per the manual  |
|                                     | Check if the water intake filter is blocked                                   | Replace the filter   |
| Water comes out of nozzle           | Abnormal operation  | Pull out the plug for a minute and then connect to power   |
| Water temperature is not sufficient | Check if water temperature is set at a low level                              | Adjust water temperature as per the manual   |
| Nozzle drips water                  | The electromagnetic valve does not work                                       | Contact our Customer Service team for further help. Call 1-888-256-7551 (CANADA), 1-888-620-3667 (USA) |
| Wash function is not functioning    | If there's any other hard object supporting the seat ring under the seat ring | Remove the hard object   |
|                                     | Human sensing of seat ring does not work                                      | Contact our Customer Service team for further help. Call 1-888-256-7551 (CANADA), 1-888-620-3667 (USA) |

# avenue



Massa ITL-5001-EW

Intelligent Toilet

## TROUBLE-SHOOTING

### Warm air/air temperature

| Symptom                          | Analysis of Issue                             | Solution   |
|----------------------------------|---|--|
| Air is cold for warm air setting | Check if warm air is set as being closed      | Adjust warm air as per the manual  |
|                                  | Check if heating part for warm air is damaged | Contact our Customer Service team for further help. Call 1-888-256-7551 (CANADA), 1-888-620-3667 (USA) |

### Seat temperature

| Symptom                                | Analysis of Issue                                     | Solution                                  |
|--|---|---|
| Seat temperature is too low/not heated | Check if seat ring temperature is set as being closed | Adjust seat temperature as per the manual |

### Remote control

| Symptom                                       | Analysis of Issue   | Solution  |
|---|---|---|
| Blue indicator for water temperature flickers | Battery is too low  | Battery is too low  |
| Remote control does not work                  | Check if positive and negative poles of the battery are connected reversely | Reinstall batteries matching negative and positive poles. |

### Ceramic body

| Symptom   | Analysis of Issue                 | Solution   |
|---|-----------------------------------|--|
| Dirt cannot be flushed thoroughly when water pressure is low                            | The filter is blocked             | Replace the filter   |
|   | Water pressure at home is too low | Check if the water volume is smaller than 0.9gal per 10 seconds  |
|   | Water supply hose is kinked       | Observe if the connecting pipe is kinked or not, replace hose and reconnect.                           |
| There's no siphon when water pressure is normal, and waste cannot be flushed thoroughly | The sewage drain outlet           | Contact our Customer Service team for further help. Call 1-888-256-7551 (CANADA), 1-888-620-3667 (USA) |
|   | The sewage pipe is blocked        | Contact a professional to clear drain lines  |
| Water pressure is normal, but flush does not work                                       | The flush valve is in fault       | Contact our Customer Service team for further help. Call 1-888-256-7551 (CANADA), 1-888-620-3667 (USA) |

### Others

| Symptom   | Analysis of Issue   | Solution   |
|---|---|--|
| The seat cover/seat ring falls down too quickly       | Function of soft close hinge does not work                            | Contact our Customer Service team for further help. Call 1-888-256-7551 (CANADA), 1-888-620-3667 (USA)   |
| Various functions work in a sequence in a cycling way | Enter engineering commissioning mode by mistake                       | Turn the power off and wait for one minute before connecting it again.   |
| Water is slowed down or does not flow at all.         | The filter itself is plugged up. The electrical power is not working. | Check the filter itself. It may need to be replaced due to clogging. Be sure the fuse is connected and working properly. Make sure that the electrical power to the house is working at full capacity. |

Avenue warrants its products to be free from defects in material or workmanship for 5 years (Vitreous China) and 1 year (Parts and Fittings) from the date of purchase of the product by the original purchaser.

If inspection of this plumbing product, within 5 years (china product) or 1 year (parts and fittings) after its initial purchase, confirms that it is defective in materials or workmanship, Avenue will repair or at its option, exchange the product for a similar model. Avenue provides no warranties or guarantees beyond those in this Limited Avenue Warranty.

This limited warranty applies only to the original purchaser and installation of these products. All de-installation and re-installation and transportation costs or charges incidental to warranty services are to be borne by the owner. In no event will Avenue be liable for the cost of repair or replacement of any installation materials, including but not limited to, tiles, marble etc. Avenue will not be responsible for and this warranty does not cover and specifically excludes any liability to the purchaser or any third party for consequential or incidental damages, all of which are hereby expressly disclaimed, or the extension beyond the duration of this warranty of any implied warranties, including those of merchantability or fitness for an intended purpose.

This warranty does not apply to local building code compliance. Since local building codes vary considerably, the purchaser of this product should check with a local building or plumbing contractor to insure local code compliance before installation.

Avenue shall not be responsible or liable for any failure or damage to its toilet tank trim, plumbing fittings, or china products caused by the use of either chloramines or high concentration of chlorine, lime/iron sediments and/or other minerals not removed from public water during the treatment of public water supplies or caused by toilet tank type cleaners containing chlorine, calcium hypochlorite, and/or other chemicals.

This warranty is void if the product has been moved from its initial place of installation; if it has been subjected to faulty maintenance, abuse, misuse, accident or other damages; if it was not installed in accordance with Avenue's instructions; or if it has been modified in a manner inconsistent with the product as shipped by Avenue.

**NOTE:** Some states or provinces do not allow the limitations on an implied warranty, and some states/provinces do not allow exclusions or limitations regarding incidental or consequential damages, so the above limitations may not apply to you. This warranty gives you specific legal rights, and you may have other rights, which vary from state to state or province to province. No person is authorized to change, add to, or creates any warranty or obligation other than that set forth herein.

**To obtain warranty service or product information call Customer Relations Department Warranty Service Group 1-888-256-7551 (Canada) or Email us: [fgicanada@fgi-industries.com](mailto:fgicanada@fgi-industries.com) or visit our Parts website: [www.fgiparts.ca](http://www.fgiparts.ca)**

This warranty gives the original purchaser of this product specific legal right, which may vary from state to state or from province to province. In some states or provinces, the exclusion or limitation of incidental or consequential damages is not allowed, so those exclusions may not apply to you.

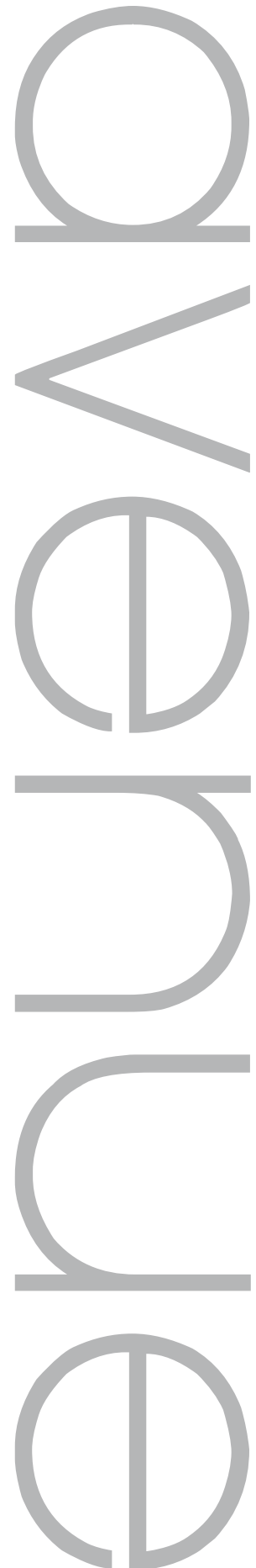

# avenue



Massa ITL-5001-EW

Intelligent Toilet

## SPECIFICATION

|  |  |   |
|--|--|---|
| Rated Voltage                          | 110V   |   |
| Rated frequency                        | 60Hz   |   |
| Rated consumption power                | Water intake temperature 15°C , water outlet temperature 39°C , flowrate 3.4gal/min<br>power 1200W |   |
| Temperature of operating environment   | 4°C - 40°C   |   |
| Water intake temperature               | 4°C - 35°C   |   |
| Range of water intake pressure for use | Min. necessary water pressure  | 35 psi (over 20 gal /min when water is running)                             |
|  | Max. water pressure  | 80 psi (in resting state)   |
| Closet                                 | Rough-in<br>12 in  |   |
| Wash                                   | Heating method   | Instantaneous heating   |
|  | Water outlet quantity for posterior wash   | About 0.14-0.18gal/min (adjustment of 3 levels) when water pressure is 0.05 |
|  | Water outlet quantity for Bidet wash   | About 0.14-0.18gal/min(adjustment of 3 levels) when water pressure is 0.05  |
|  | Temperature of warm water  | Off /about 30°C -40°C   |
|  | Safety unit  | Butterfly temperature controller, temperature fuse and flowrate test unit   |
| Warm air                               | Warm air temperature   | Off /about 35°C -55°C (adjustment of 4 levels)                              |
|  | Wind speed   | About 4m/s  |
|  | Safety unit  | Double metal plate temperature controller, temperature fuse                 |
| Seat ring                              | Seat ring temperature  | Off /about 28°C -40°C (adjustment of 4 levels)                              |
|  | Safety unit  | Temperature fuse  |
| Remote control                         | Dimension  | 7 in L × 2½ in W × ¾ in H   |
|  | Power supply   | AAA (not included)  |
| Water-proof grade                      | IPX4   |   |
| Length of power cable                  | About 47¼" in  |   |
| Dimension of the product               | 26¾ in L × 16 in W × 20¾ in H  |   |



# avenue



Massa ITL-5001-EW

Intelligent Toilet

## FUNCTIONS OF PRODUCTS

| Category                          | Function                                   | ITL-5001-EW |
|-----------------------------------|--|-------------|
| Cleaning                          | Posterior (Rear cleaning)                  | ●           |
|                                   | Bidet (Front cleaning)                     | ●           |
|                                   | One-key cleaning & drying                  | ●           |
|                                   | Oscillating cleaning                       | ●           |
|                                   | Hot & cold massage cleaning                | ●           |
|                                   | Water pressure adjustment                  | ●           |
|                                   | Water temperature adjustment               | ●           |
|                                   | Nozzle position adjustment                 | ●           |
|                                   | Self-cleaning nozzle                       | ●           |
|                                   | Antibacterial nozzle                       | ●           |
| Comfort                           | Seat heating                               | ●           |
|                                   | Warm wind drying                           | ●           |
|                                   | Soft close seat cover                      | ●           |
|                                   | Seat ring temperature adjustment           | ●           |
|                                   | Warm wind temperature adjustment           | ●           |
| Convenience                       | Night-light                                | ●           |
|                                   | Variable frequency instant heating         | ●           |
|                                   | Side button control                        | ●           |
|                                   | Automatic flush                            | ●           |
|                                   | Remote control flush                       | ●           |
|                                   | Foot touch control                         | ●           |
|                                   | Warm wind simultaneously performs flushing | ●           |
| Safety and environment protection | Water purification                         | ●           |
|                                   | Ultraviolet sterilization                  | ●           |
|                                   | Air isolation channel                      | ●           |
|                                   | Backflow prevention                        | ●           |
|                                   | Business mode                              | ●           |
|                                   | Nano glaze                                 | ●           |
|                                   | Eight-fold protection                      | ●           |

Remarks: ● signifies that the product has this function.

Please read this product manual carefully before installation and use. Save these instructions.