

Ecostat
Thermostatic Trim S with Volume Control
 Finishes : **brushed nickel** Part no. : **04230820**



Description

Features

- Volume control for 1 outlet
- Flow: 6.0 GPM (22.7 L/Min)
- Thermostatic cartridge, Ceramic cartridge
- Anti-scald 100° safety stop

Item details

List Price \$ 752.00

Compliance



Product image



Scale drawing

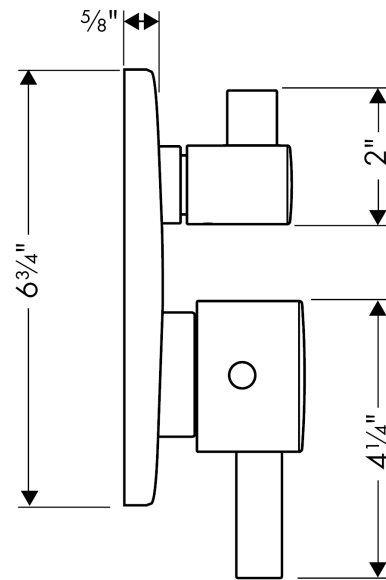

Ecostat

Thermostatic Trim S with Volume Control

Finishes : **brushed nickel** Part no. : **04230820**



Exploded drawing

Year of production: >12/09

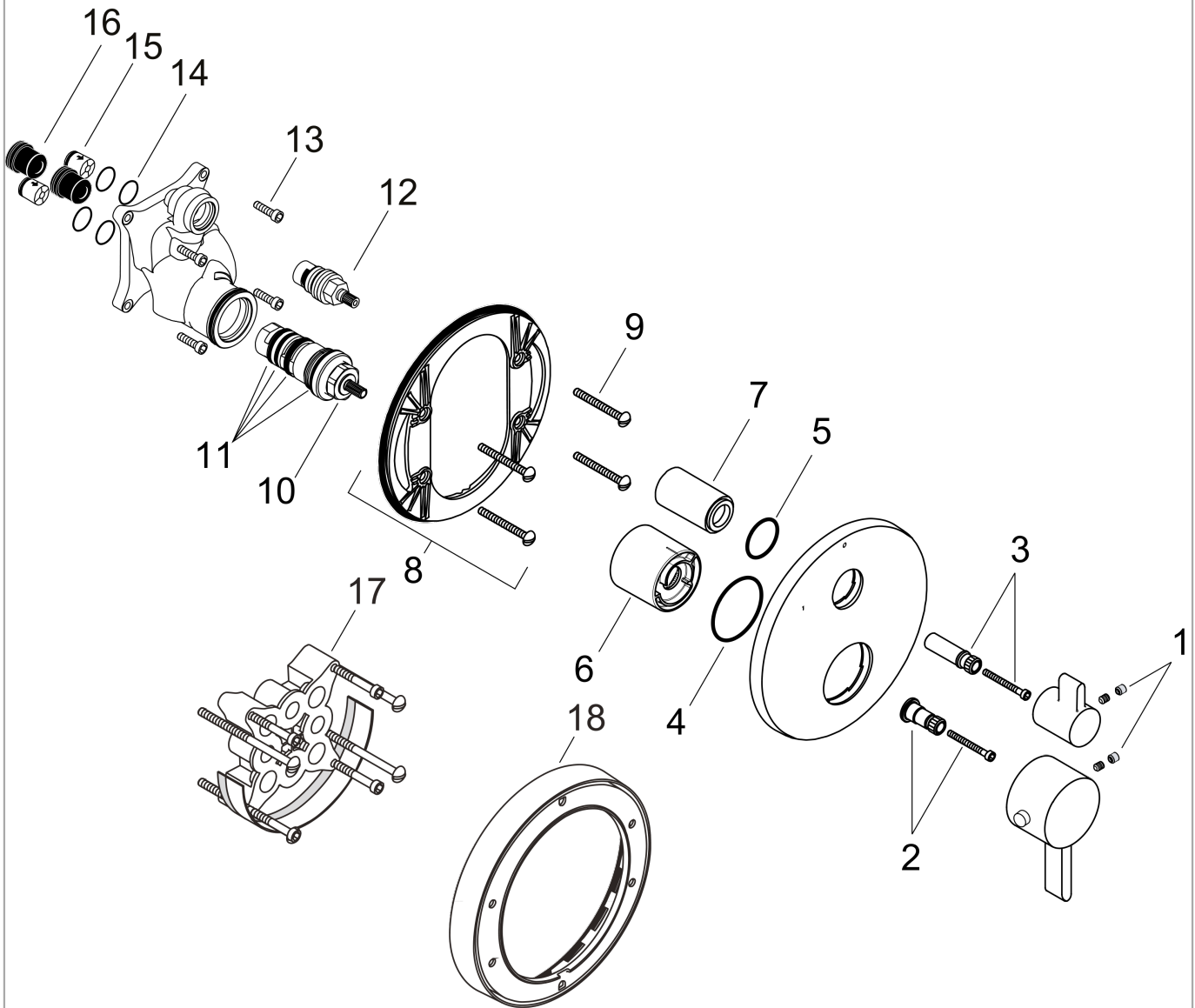

Ecostat

Thermostatic Trim S with Volume Control

Finishes : **brushed nickel** Part no. : **04230820**



Spare parts list

Year of production: >12/09

Pos.	Description	Part no.	Price	PU
1	screw cover	95181000	-	1
2	adapter for handle	96435000	-	1
3	adapter for handle	96451000	-	1
4	O-Ring 48x3	95508000	-	1
18	O-ring 29x3	98371000	-	1
5	sleeve	95550820	-	1
6	sleeve	96446820	-	1
7	sub plate	96447000	-	1
8	set of fixing screws	96454000	-	1
9	thermostat cartridge	94282000	-	1
10	sealing set	95037000	-	1
11	shut off unit right closing	94009000	-	1
12	set of screws	96525000	-	1
13	O-ring 16x2	98133000	-	1
14	set of non return valves DW 15	94074000	-	1
15	noise reduction	94073000	-	1
17	extension 25 mm	13595000	-	1
16	extension 22 mm (Ø 170 mm)	13596820	-	1
a	hexagon socket screw M4x35	92160000	-	1