

**ASSEMBLY INSTRUCTION****3FRVL or C****FLOOR MOUNT TUB FILLER WITH HAND HELD SHOWER****3FRVL****3FRVC****REMOVAL OF FIXTURE:**

Always turn the water supply off before removing the existing fixture or disassembling a valve. Open both fixture handles to relieve water pressure and to ensure that the water has been successfully turned off.

**CARE OF FIXTURE:**

The use of warm water and a soft cloth is all that is required to clean Rubinet products. The patina of our living finishes (Oil Rubbed Bronze & Tuscan Brass) will change as a result of normal use. Applying Mineral Oil on occasion will create a softer look, subtle color changes and character.

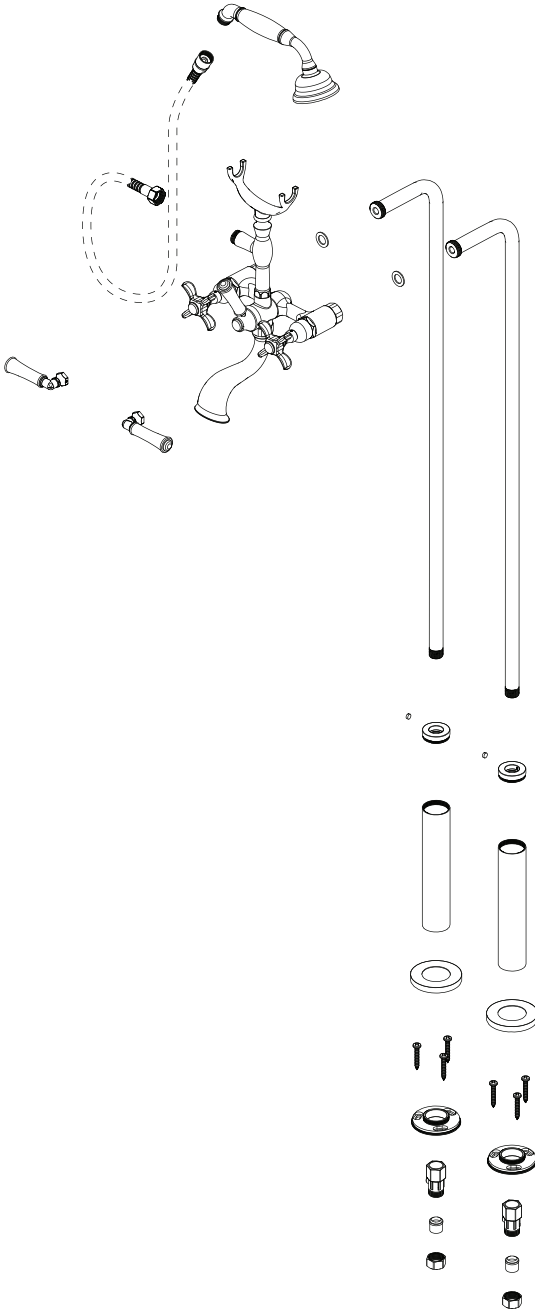

1

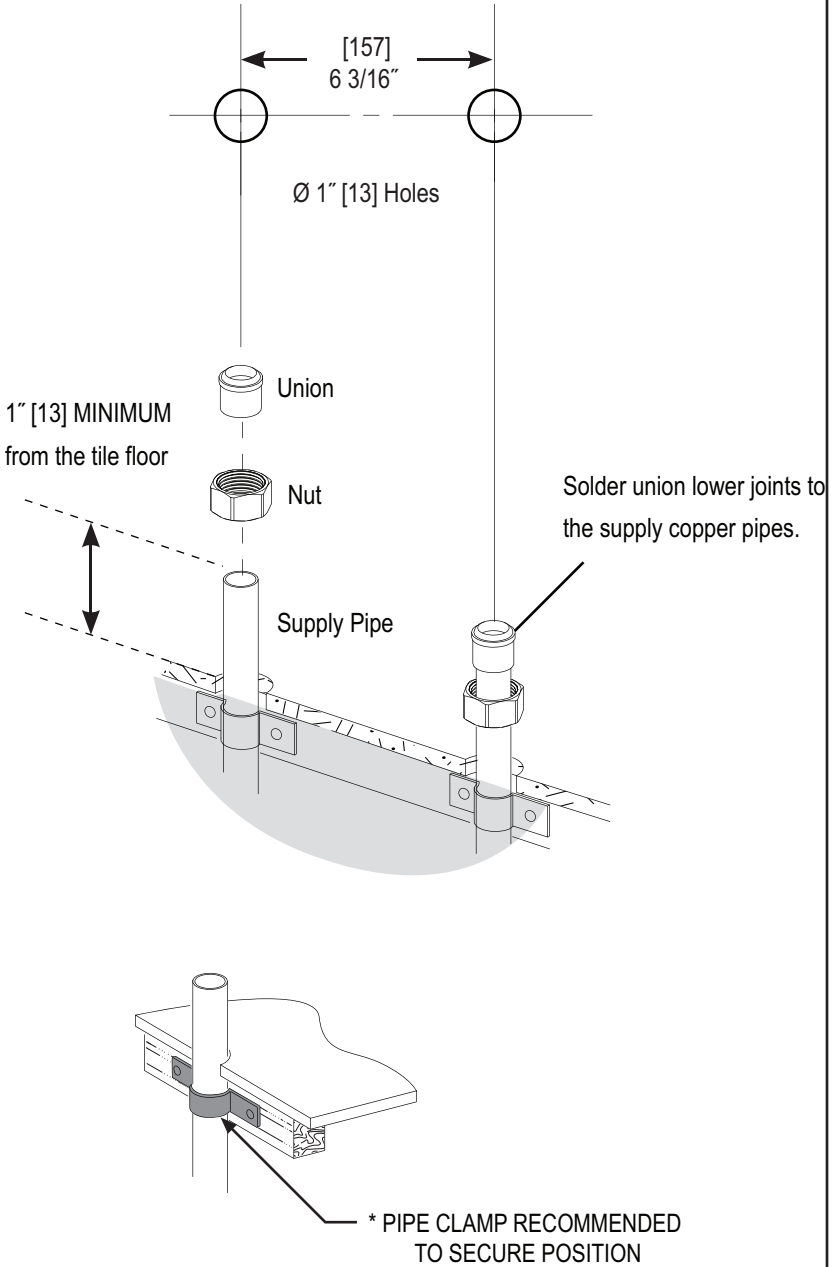

2

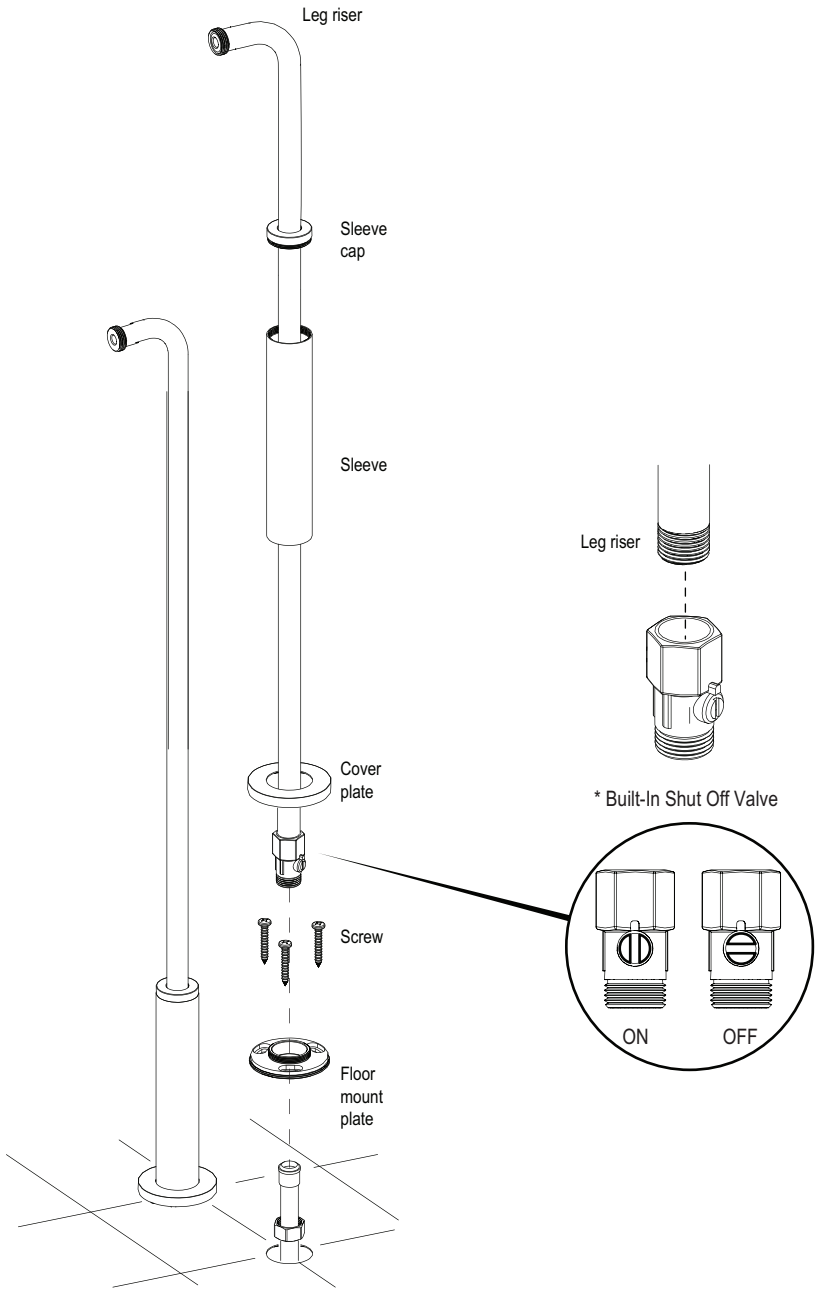

3

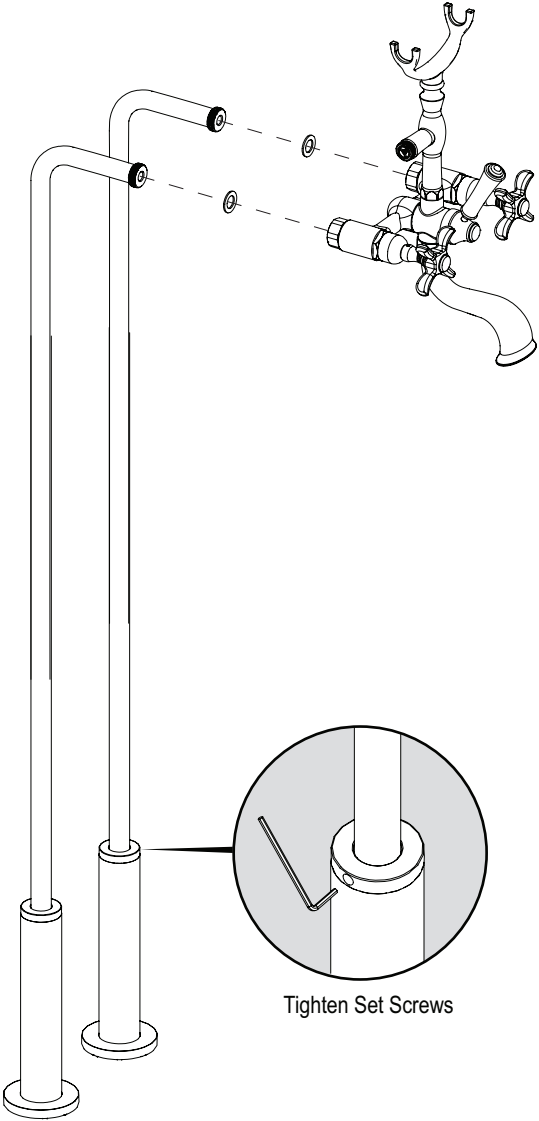

4

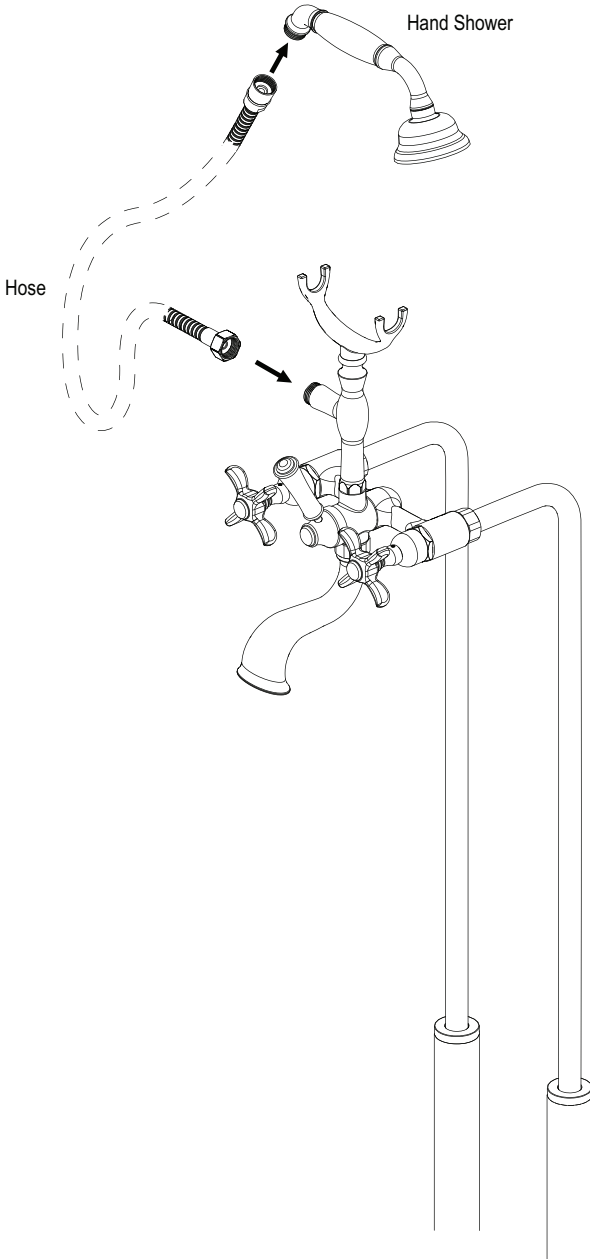

## REMOVING DIVERTER CARTRIDGE

1. Remove the diverter handle. (center)
2. Remove the shaft using wrench.
3. Remove diverter cartridge.

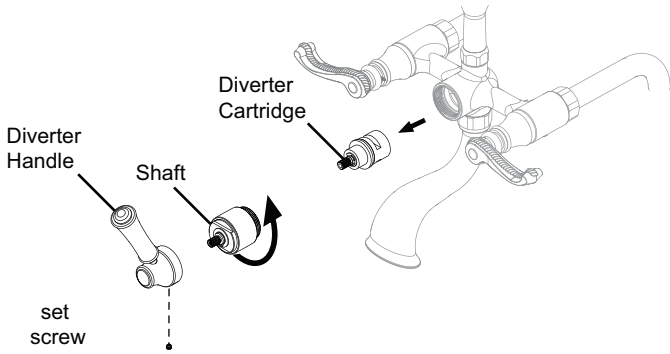

## REPLACING DIVERTER CARTRIDGE

Align notch to the matching hole to ensure proper assembly

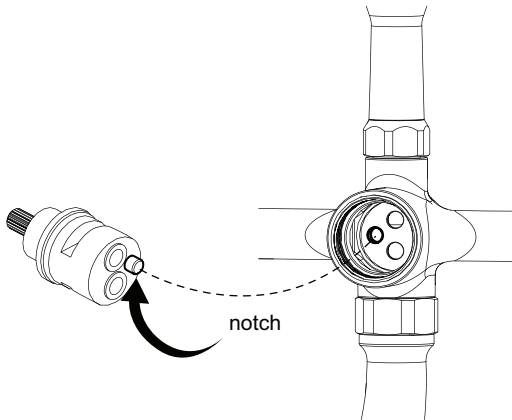

**FEATURES:**

- Brass construction with choice of 21 finishes
- Quarter Turn adjustable, ceramic disc cartridges
- Two Lever or Cross handles
- Hand Held Shower with 60" Hose (2.8 gpm @ 50 psi)
- Tub Spout (6.4 gmp @ 50 psi)
- Built-in double check valve

**APPROVAL:**

- AB1953 / NSF61
- ASME A 112.18.1
- CSA B125.1

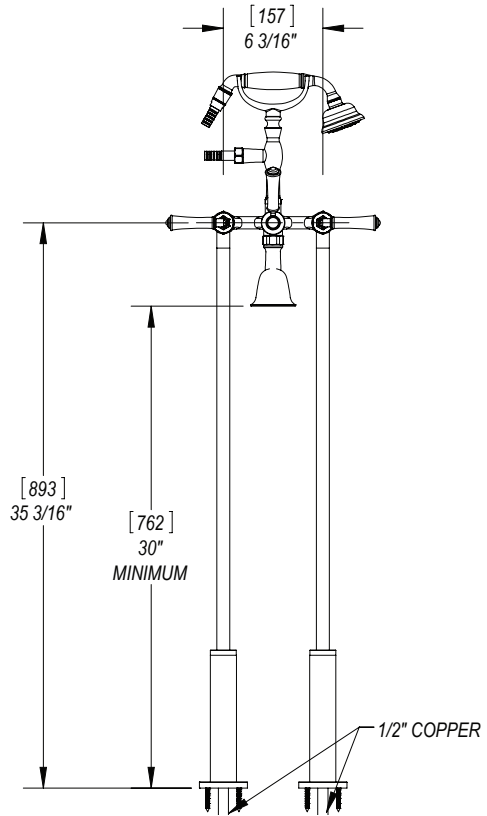
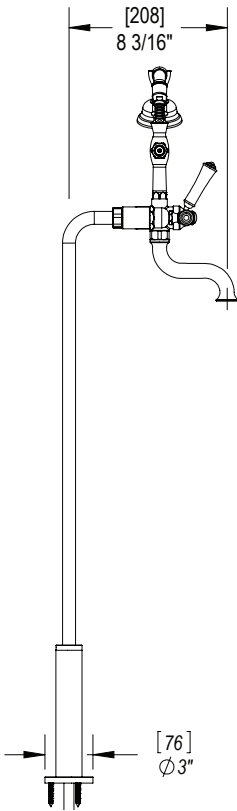

**CONTACT US:**

If you need assistance with installation, replacement parts or have any questions regarding your Rubinet product, please call a Customer Service representative at: 905-851-6781 toll free 1-800-461-5901 or visit [www.rubinet.com](http://www.rubinet.com)