

CODE NUMBER

10021201

DESCRIPTION

SU-1009 Urinal and SOLIS 8186 Flushometer.

COMPONENTS

- Flushometer: Code 3370005
- Urinal: Code 1101009

DETAILS

- Flush Volume: 0.25 gpf (0.9 Lpf)
- Nominal Dimensions: 14 ¼" x 17 ¼" x 25 ½" (362 x 438 x 648mm)

FLUSHOMETER FEATURES

- Handle Packing, Main Seat, Stop Seat and Vacuum Breaker Molded from PERMEX® Rubber Compound for Chloramine resistance
- User friendly three (3) second Flush Delay
- "Low Battery" Flashing LED
- Sweat solder adapter with cover tube and cast wall flange with set screw
- Solar Powered. The sensor assembly is powered by a solar cell that will harvest power from artificial indoor light, either incandescent or fluorescent light, and use it as the energy source. The solar cell can provide approximately 100% power with 650 Illuminance (lux).
- Four (4) Size AA Battery Back-up Power Source
- Synthetic rubber seals for chloramine resistance
- Infrared Sensor with Multiple-focused, Lobular Sensing Fields for high and low target detection
- Fixed Metering Bypass and No External Volume Adjustment to Ensure Water Conservation
- Flex Tube Diaphragm designed for improved life and reduced maintenance
- Engineered Metal Cover with replaceable Lens Window
- ADA Compliant Sloan Solis® Solar Powered Infrared Sensor for automatic "No Hands" operation
- ADA Compliant Solis® Solar Powered Infrared Sensor for automatic "No Hands" operation
- 3/4" IPS screwdriver Bak-Chek® angle stop with vandal resistant stop cap
- Courtesy Flush® Override Button

FIXTURE FEATURES

- White Vitreous China
- Washdown flushing action
- Integral flushing rim
- ¾" I.P.S. top spud inlet
- 2" NPT outlet flange
- Vandal resistant strainer assembly included
- All mounting hardware included
- 100% factory flush tested



COMPLIANCES & CERTIFICATIONS



(ADA Compliant, cUPC Green Certified, WaterSense Listed, BAA Compliant, Satisfies LEED Credits, HPD, EPD)

DOWNLOADS

- [Standard Spud Urinal Installation Instructions](#)
- [SS/ST/SU/WETS/WEUS Fixtures Repair and Maintenance Guide](#)
- [Additional Downloads](#)

NOTES

All information contained within this document subject to change without notice.

Sloan 10500 Seymour Ave, Franklin Park, IL 60131

Phone: 800.982.5839 • Fax: 800.447.8329 • sloan.com

ROUGH-IN

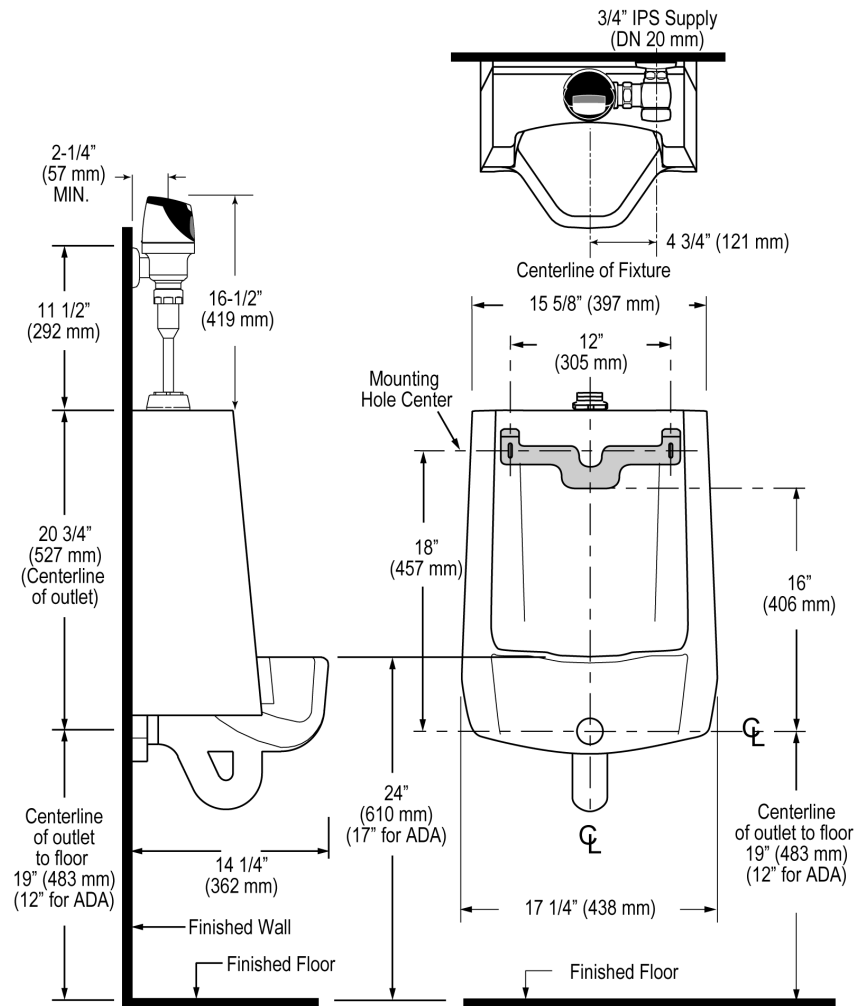

Sloan 10500 Seymour Ave, Franklin Park, IL 60131
Phone: 800.982.5839 • Fax: 800.447.8329 • sloan.com