

**CODE NUMBER**

3522662

**DESCRIPTION**

2.4 gpf, Rough Brass Finish, Single Flush, 2-10.75 L Dimension, Crown® Concealed Manual Specialty Water Closet Hydraulic Flushometer.

**DETAILS**

- Flush Volume: 2.4 gpf (9.1 Lpf)
- Finish: Rough Brass (RB)
- Valve: Piston
- Valve Body Material: Semi-red Brass
- Fixture Type: Water Closet
- Fixture Connection: Rear spud
- Spud Coupling: 1 ½" (38mm)
- L Dimension: 2" - 10 ¾" (51 - 273mm) (2-10-3/4-LDIM)

**FEATURES**

- ADA Compliant Non-Hold-Open Actuator
- Valve designed to accept Low and Ultra-Low Consumption Pistons only to ensure Water Conservation
- Double Slip Elbow Flush Connection
- Main Seat, Handle Packing, Stop Seat and Vacuum Breaker to be molded from PERMEX® Rubber Compound for Chloramine Resistance.
- Fixed Volume Piston with Filtered O-ring Bypass
- 1" I.P.S. Wheel Handle Bak-Chek® Angle Stop
- Actuator not included, order separately. Specify actuator type based on **Hydraulic Push Button Options**



**COMPLIANCES & CERTIFICATIONS**



(ADA Compliant, cUPC Certified, BAA Compliant, WaterSense Listed, cUPC Green Certified)

**RECOMMENDED SPECIFICATION**

Valve Body, Cover, Tailpiece and Control Stop shall be in conformance with ASTM Alloy Classification for Semi- Red Brass. Valve shall be in compliance with the applicable sections of ASSE 1037 and ANSI/ASME 112.19.2.

**VALVE OPERATING PRESSURE (FLOWING)**

15-80 PSI (103-552 kPa). Specific fixtures may require greater minimum flowing pressure - consult manufacturer requirements.

**DOWNLOADS**

- [Sloan Piston Type Exposed Installation Instructions](#)
- [Control Stop Repair and Maintenance Guide](#)
- [Flush Connections Flanges Repair and Maintenance Guide](#)
- [Tail Piece Repair and Maintenance Guide](#)
- [Crown/Crown II Repair and Maintenance Guide](#)
- [Series 900 Flushometers Repair and Maintenance Guide](#)
- [Hydraulic Push Button Options](#)
- [Additional Downloads](#)

**NOTES**

All information contained within this document subject to change without notice.

Looking for other variations of the CROWN 952 product? [View the general spec sheet with all options.](#)

[Find a compatible urinal](#) for this flushometer.

[Find a compatible water closet](#) for this flushometer.

Watersense compliant when used with a WaterSense compliant fixture

**Sloan 10500 Seymour Ave, Franklin Park, IL 60131**

Phone: 800.982.5839 • Fax: 800.447.8329 • [sloan.com](http://sloan.com)

**ROUGH-IN**

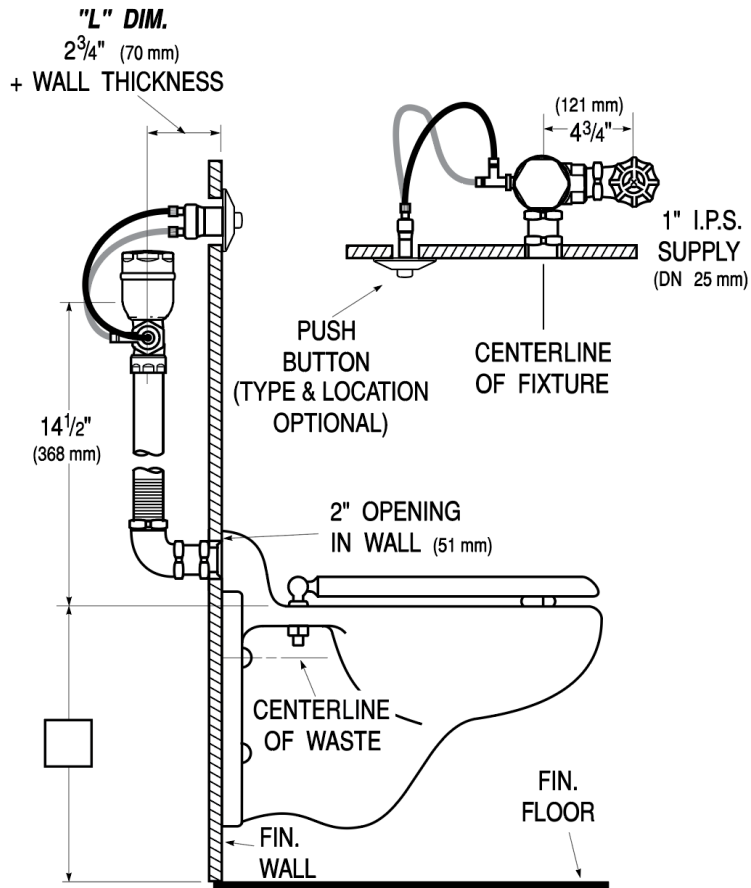

Sloan 10500 Seymour Ave, Franklin Park, IL 60131  
Phone: 800.982.5839 • Fax: 800.447.8329 • [sloan.com](http://sloan.com)