

INDUSTRIAL 24" HEAVY DUTY APPLIANCE PULL

HIP-2400

- Break to length screws
- Fits materials from 1/2" to 1-1/2" thick

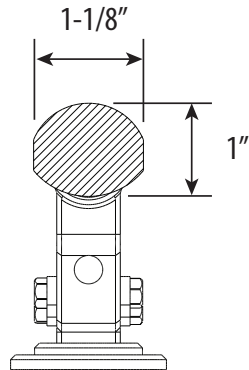

END VIEW

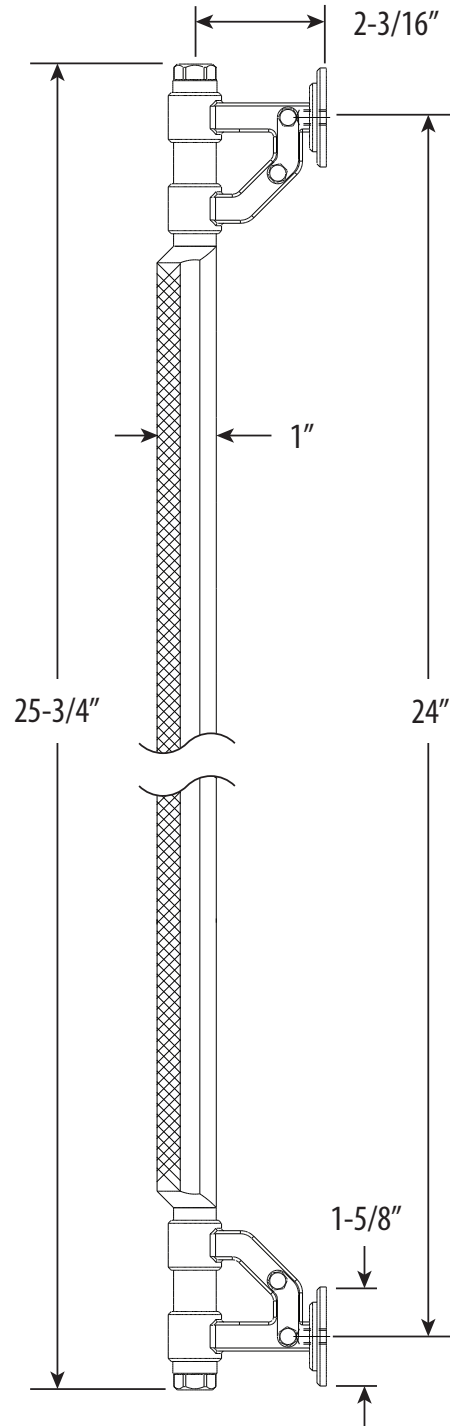

DIMENSIONS MAY VARY AND ARE SUBJECT TO CHANGE. NO RESPONSIBILITY IS ASSUMED FOR USE OF SUPERCEDED OR VOIDED DATA